

WindEnergy Hamburg 2024

Danish Energy Export



Table of Contents

| | |
|---|----|
| Cover | 1 |
| Table of Contents | 2 |
| 3D View 1 | 3 |
| 3D View 2 | 4 |
| 3D View 3 | 5 |
| 3D View 4 | 6 |
| Floor Plan B1.EG | 7 |
| Floor Plan B2.EG | 8 |
| Where to find your graphic measurements | 9 |
| Where to find your graphic measurements | 10 |
| Graphics Dimensions - B1.EG | 11 |
| Graphics Dimensions - B1.EG | 12 |
| Graphics Dimensions - B1.EG | 13 |
| Graphics Dimensions - B1.EG | 14 |
| Graphics Dimensions - B1.EG | 15 |
| Graphics Dimensions - B1.EG | 16 |
| Graphics Dimensions - B1.EG | 17 |
| Graphics Dimensions - B1.EG | 18 |
| Graphics Dimensions - B1.EG | 19 |
| Graphics Dimensions - B1.EG | 20 |
| Graphics Dimensions - B1.EG | 21 |
| Graphics Dimensions - B1.EG | 22 |
| Graphics Dimensions - B1.EG | 23 |
| Graphics Dimensions - B1.EG | 24 |
| Graphics Dimensions - B2.EG | 25 |
| Graphics Dimensions - B2.EG | 26 |
| Graphics Dimensions - B2.EG | 27 |
| Info | 28 |

3D View 1



3D View 2



3D View 3



3D View 4



Floor Plan B1.EG

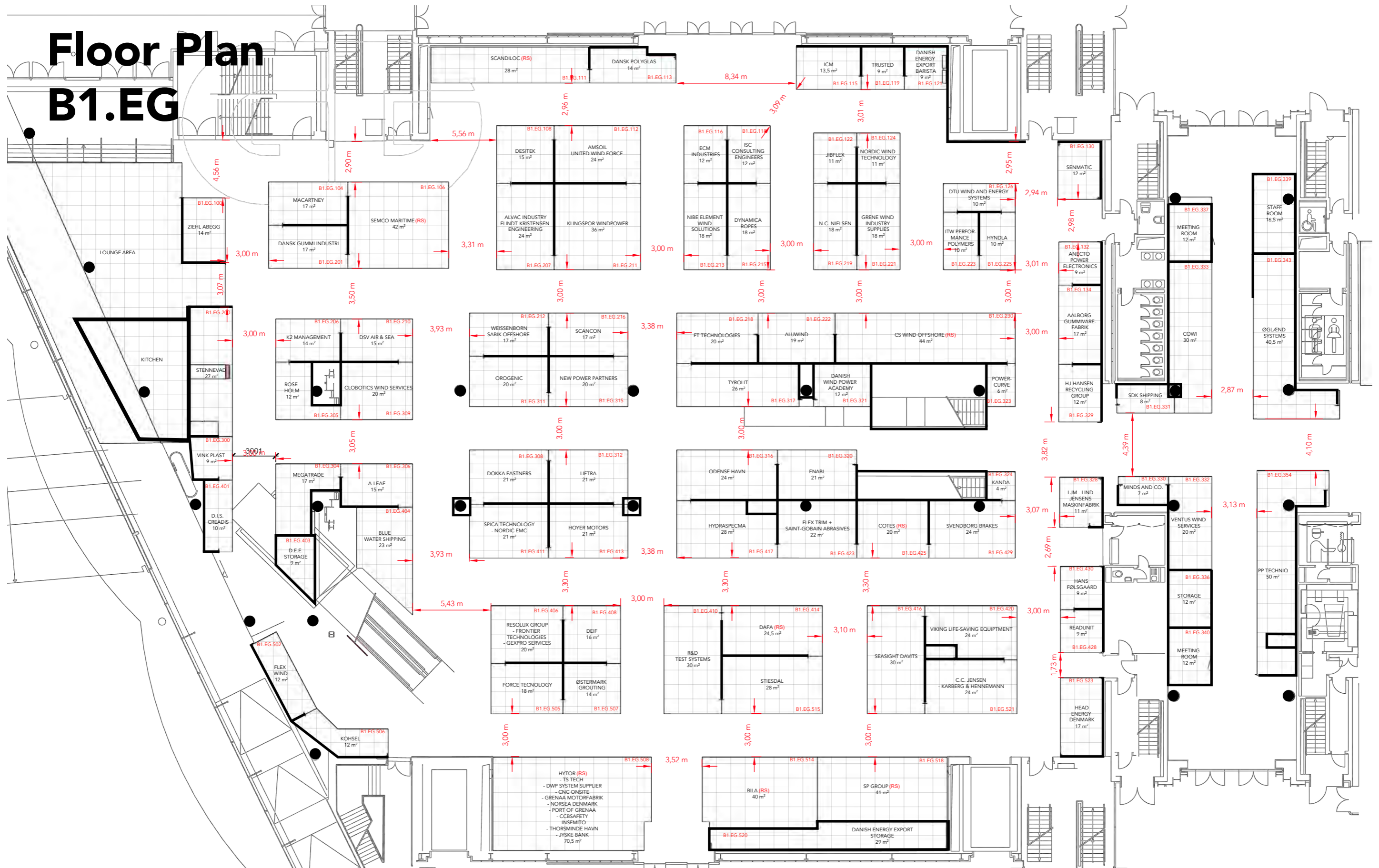

Floor Plan B2.EG

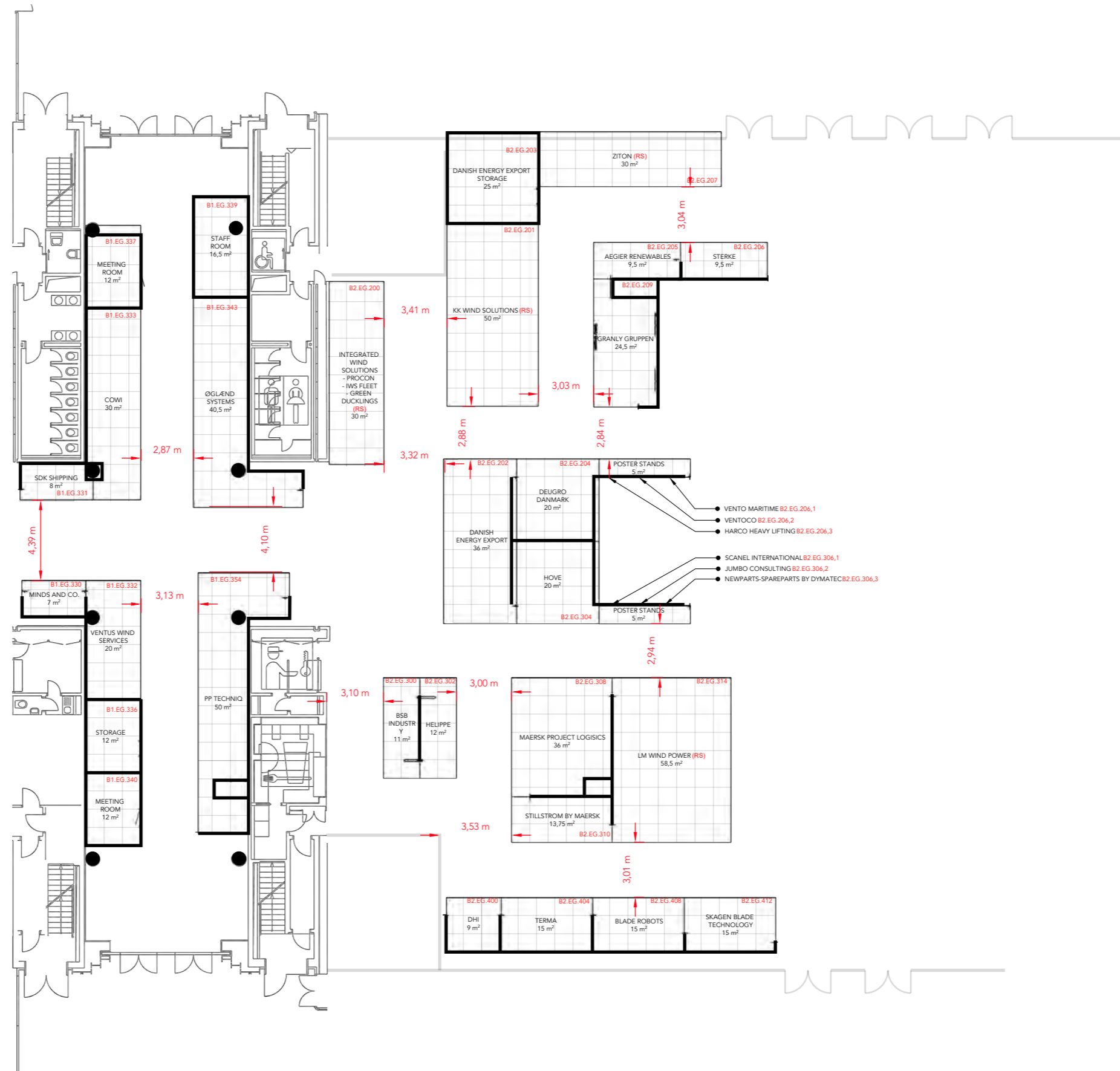

Where to find your graphic measurements

Page 11

D.I.S CREADIS
STENNEVAD
VINK PLAST

Page 12

DSV AIR & SEA
K2 MANAGEMENT
MACARTNEY
DANSK GUMMI INDUSTRI
SEMCO MARITIME
ZIEHL-ABEGG

Page 13

A-LEAF
CLOBOTICS WIND SERVICE
DSV AIR & SEA
DOKKA FASTENERS
K2 MANAGEMENT
LIFTRA
NEW POWER PARTNERS
OROGENIC
ROSE HOLM
SCANCON
WEISSENBORN, SABIK OFFSHORE

Page 14

A-LEAF
DEIF
BLUE WATER SHIPPING
DEE STORAGE
DOKKA FASTENERS
LIFTRA
HOYER MOTORS
MEGATRADE
RESOLUX GROUP – FRONTIER TECHNOLOGIES - GEXPRO SERVICES
SPICA TECHNOLOGY, NORDIC EMC

Page 15

DEIF
FLEX WIND
FORCE TECNOLOGY
KOHSEL
RESOLUX GROUP – FRONTIER TECHNOLOGIES - GEXPRO SERVICES
ØSTERMARK GROUTING

Page 16

ALVAC, FLINDT-KRISTENSEN ENGINEERING
AMSOIL, UNITED WIND FORCE
KLINGSPOR WINDPOWER
DANSK POLYGLAS
DESITEK
DYNAMICA ROBES
ECM INDUSTRIES
ISC CONSULTING ENGINEERS
NIBE ELEMENT WIND SOLUTIONS
SCANDILOC

Page 17

COTES
CS WIND OFFSHORE
DANISH WIND POWER ACADEMY
ENABL
FLEX TRIM + SAINT-GOBAIN ABRASIVES
FT TECHNOLOGIES
HYDRASPECMA
KANDA
ODENSE HAVN
POWERCURVE
SVENDBORG BRAKES
TYROLIT
ALUWIND

Page 18

DAFA
DEIF
FORCE TECNOLOGY
R&D TEST SYSTEMS
RESOLUX GROUP – FRONTIER TECHNOLOGIES - GEXPRO SERVICES
STIESDAL
ØSTERMARK GROUTING

Page 19

BILA
FORECE TECHNOLOGY
HYTOR, TS TECH, DWP SYSTEM SUPPLIER, CNC ONSITE, GRENA
MOTORFABRIK, NORSEA DENMARK, PORT OF GRENA, CCB
SAFETY, INSEMITO, THORSMINDE HAVN, JYSKE BANK
STIESDAL
ØSTERMARK GROUTING

Where to find your graphic measurements

Page 20

BILA
C.C. JENSEN - KARBERG & HENNEMANN
SP GROUP
STIESDAL
DANISH ENERGY EXPORT STORAGE

Page 21

DANISH ENERGY EXPORT BARISTA
DTU WIND AND ENERGY SYSTEMS
DYNAMICA ROBES
ECM INDUSTRIES
GRENE WIND INDUSTRY SUPPLIES
HYNDLA
ITW PERFORMANCE POLYMERS
ICM
ISC CONSULTING ENGINEERS
JIBFLEX
N.C. NIELSEN
NIBE ELEMENT WIND SOLUTIONS
NORDIC WIND TECHNOLOGY
SENMATIC
TRUSTED

Side 22

ANECTO POWER ELECTRONICS
COWI
HJ HANSEN RECYCLING GROUP
MEETING ROOM
STAFF ROOM
ØGLÆND SYSTEM
AALBORG GUMMIVAREFABRIK
SDK SHIPPING

Side 23

C.C. JENSEN - KARBERG & HENNEMANN
HANS FØLSGAARD
HEAD ENERGY DENMARK
READUNIT
SEASIGHT DAVITS
VIKING LIFE-SAVING EQUIPMENT

Side 24

HANS FØLSGAARD
LJM – LIND JENSENS MASKINFABRIK
MEETING ROOM
MINDS AND CO.
PP TECHNIQ
READUNIT
STORAGE
VENTUS WIND SERVICES

Side 25

DANISH ENERGY EXPORT STORAGE
INTEGRATED WIND SOLUTIONS, PROCON, IWS FLEET, GREEN DUCKLINGS
KK WIND SOLUTIONS
GRANLY GRUPPEN
STERKE
AEGIER RENEWABLES
ZITON

Side 26

DANISH ENERGY EXPORT
HOVE
DEUGRO DANMARK
POSTER STANDS (VENTO MARITIME, VENTOCO, HARCO HEAVY LIFTING, SCANEL INTERNATIONAL, JUMBO CONSULTING, NEWPARTS-SPAREPARTS BY DYMATEC – NB! The graphic dimensions are: W:1276 mm x H: 2380mm).

Side 27

BLADE ROBOTS
BSB INDUSTRY
DHI
HELIPPE
LM WIND POWER
MAERSK PROJECT LOGISTICS
SKAGEN BLADE TECHNOLOGY
STILLSTROM BY MAERSK
TERMA

Graphics Dimensions - B1.EG

- Full size Fabric
- Single Frame Fabric
- Single Frame Panel

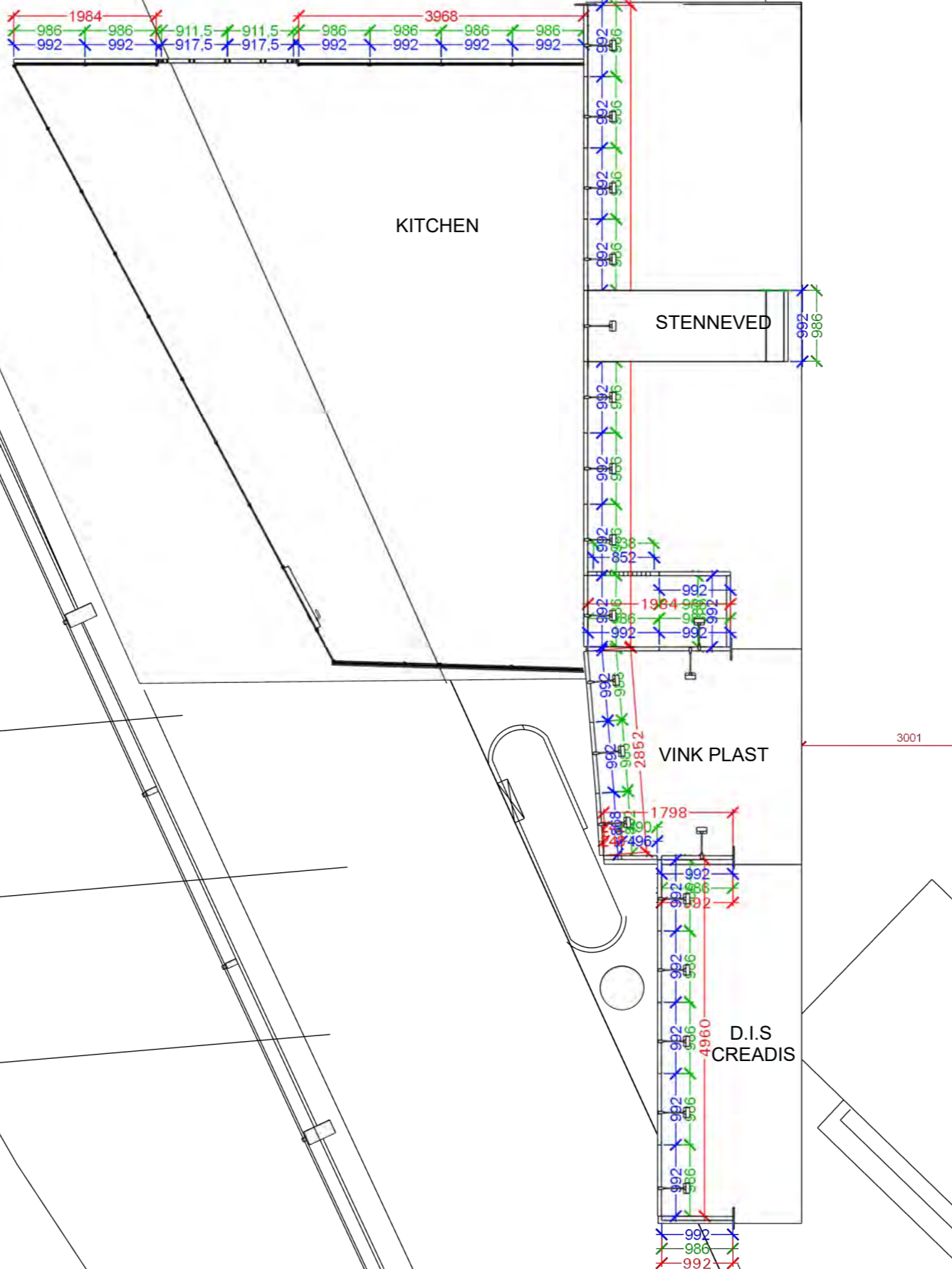

Client: Danish Energy Export
Exhibition: WindEnergy Hamburg 2024

The drawing is indicative and without responsibility. The drawing is NOT to scale. The stand-builder will have the final call in all decisions regarding stability and security. Some products are only shown to indicate locations, but not the actual product as this product may be changed. All design is subject to copyright by Compass Fairs A/S and Standesign A/S

Project no.: EXP-WEN-24-09
Designed By: SFT + SMM + THJ
Hall: B1.EG + B2.EG
Booth: Multiple

Creation Date: 11.01.2024
Revision Date: 28.08.2024
Revision no.: Z

Graphics Dimensions - B1.EG

- Full size Fabric
- Single Frame Fabric
- Single Frame Panel

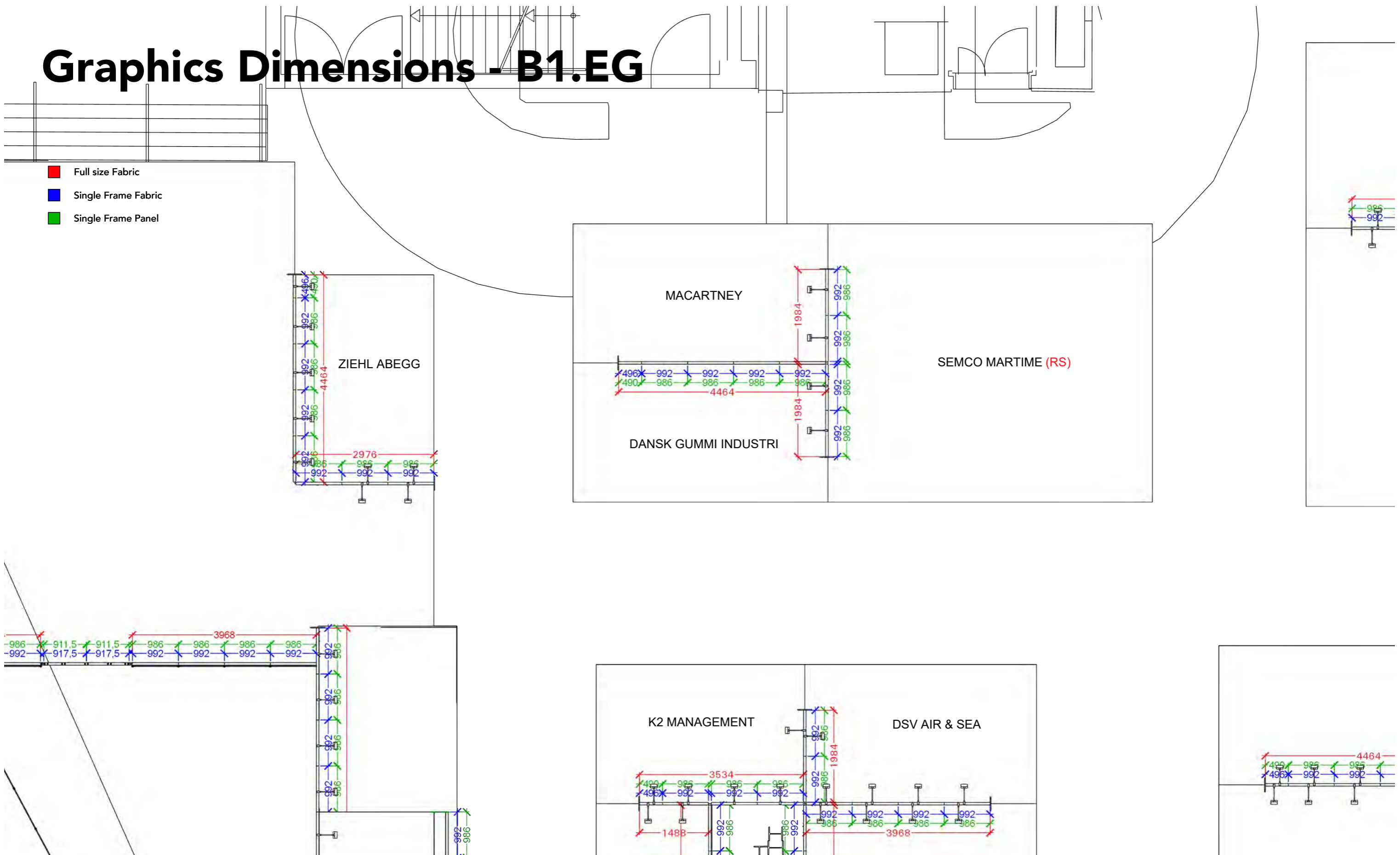

Graphics Dimensions - B1.EG

- Full size Fabric
- Single Frame Fabric
- Single Frame Panel

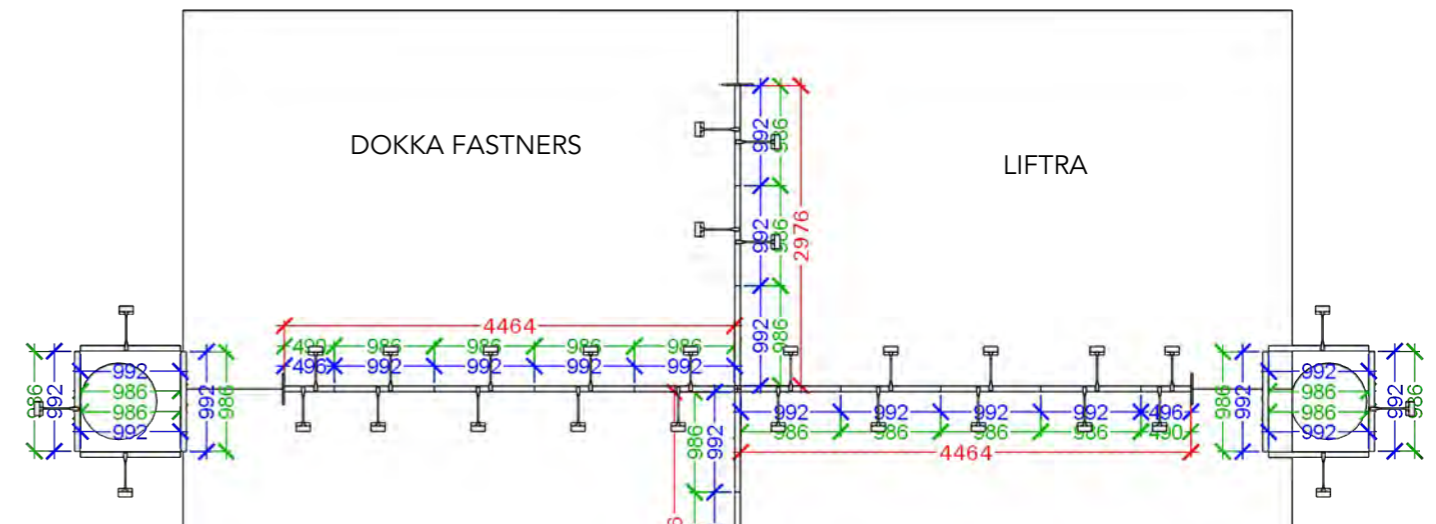
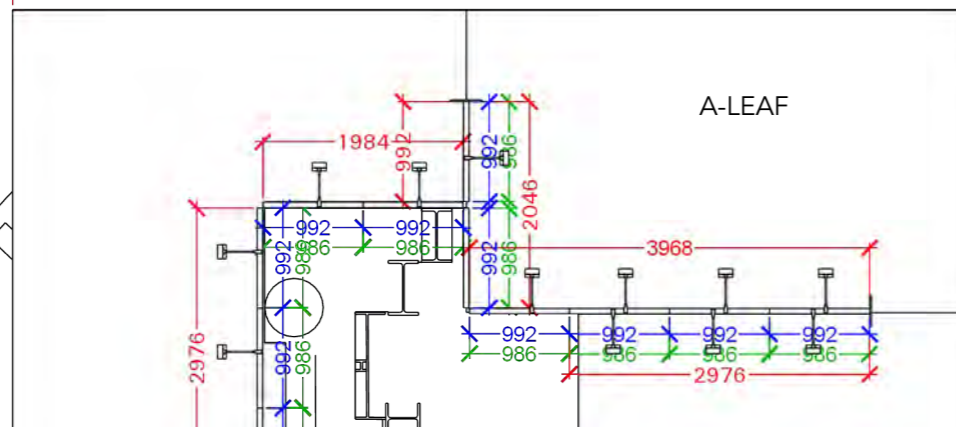
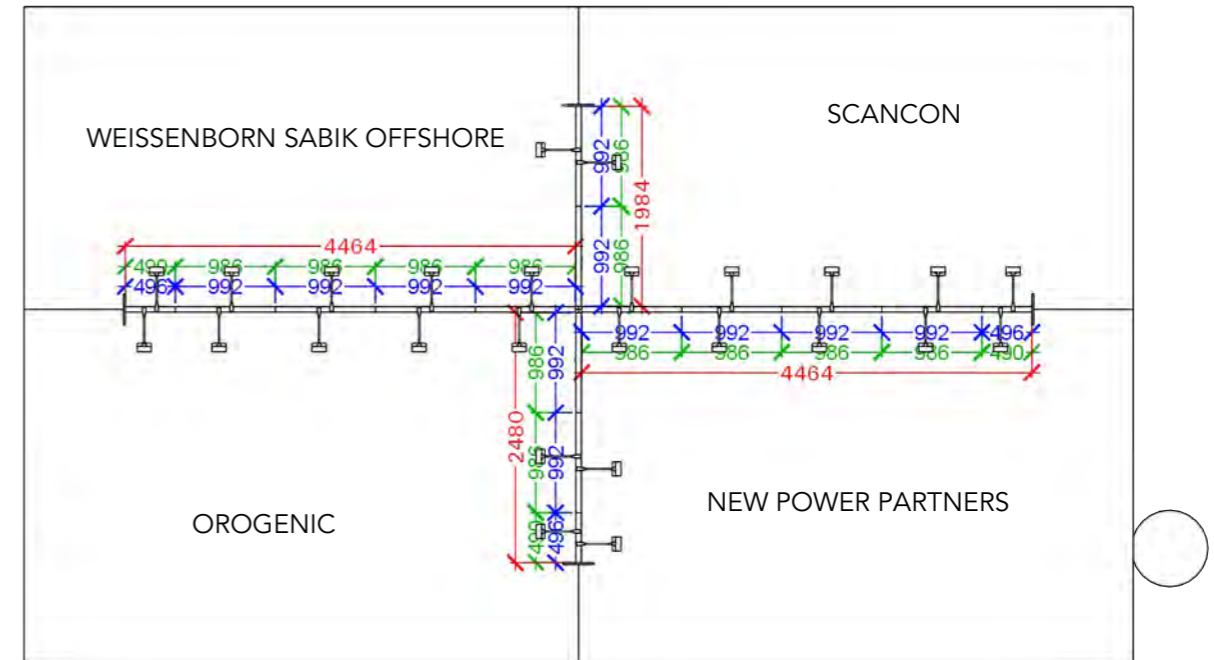
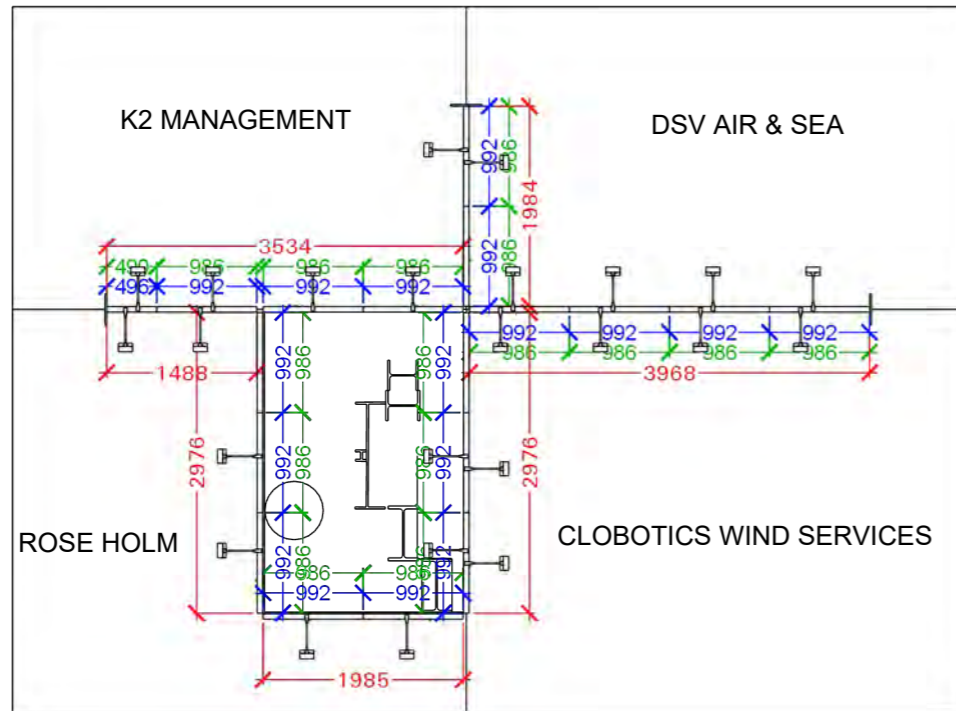

Graphics Dimensions - B1.EG

- Full size Fabric
- Single Frame Fabric
- Single Frame Panel

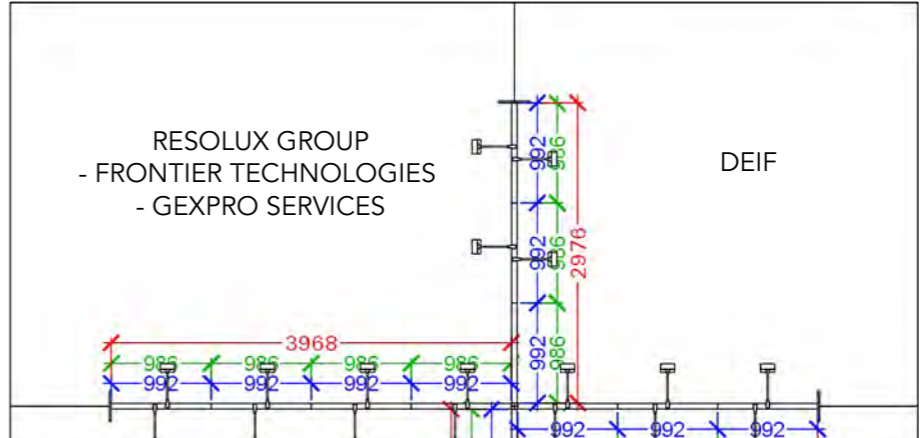
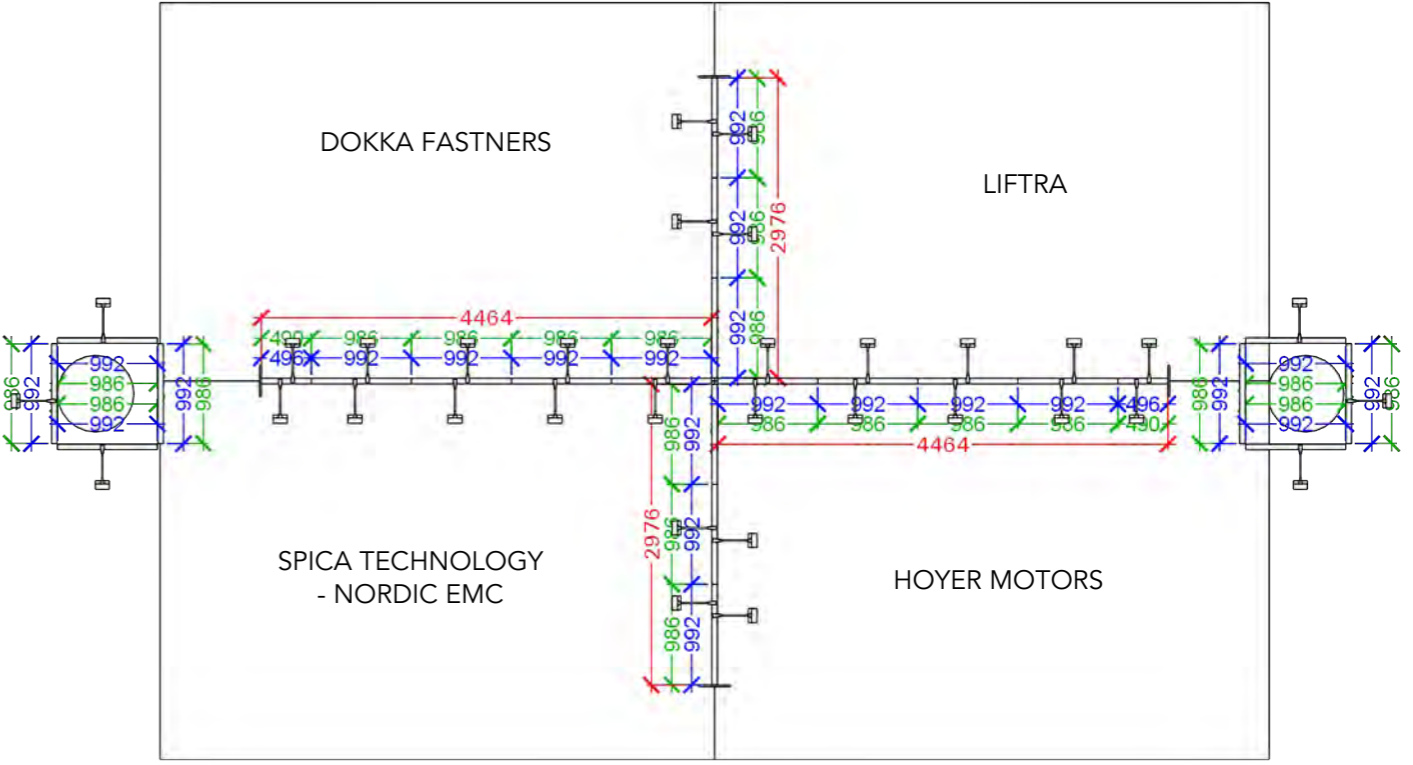
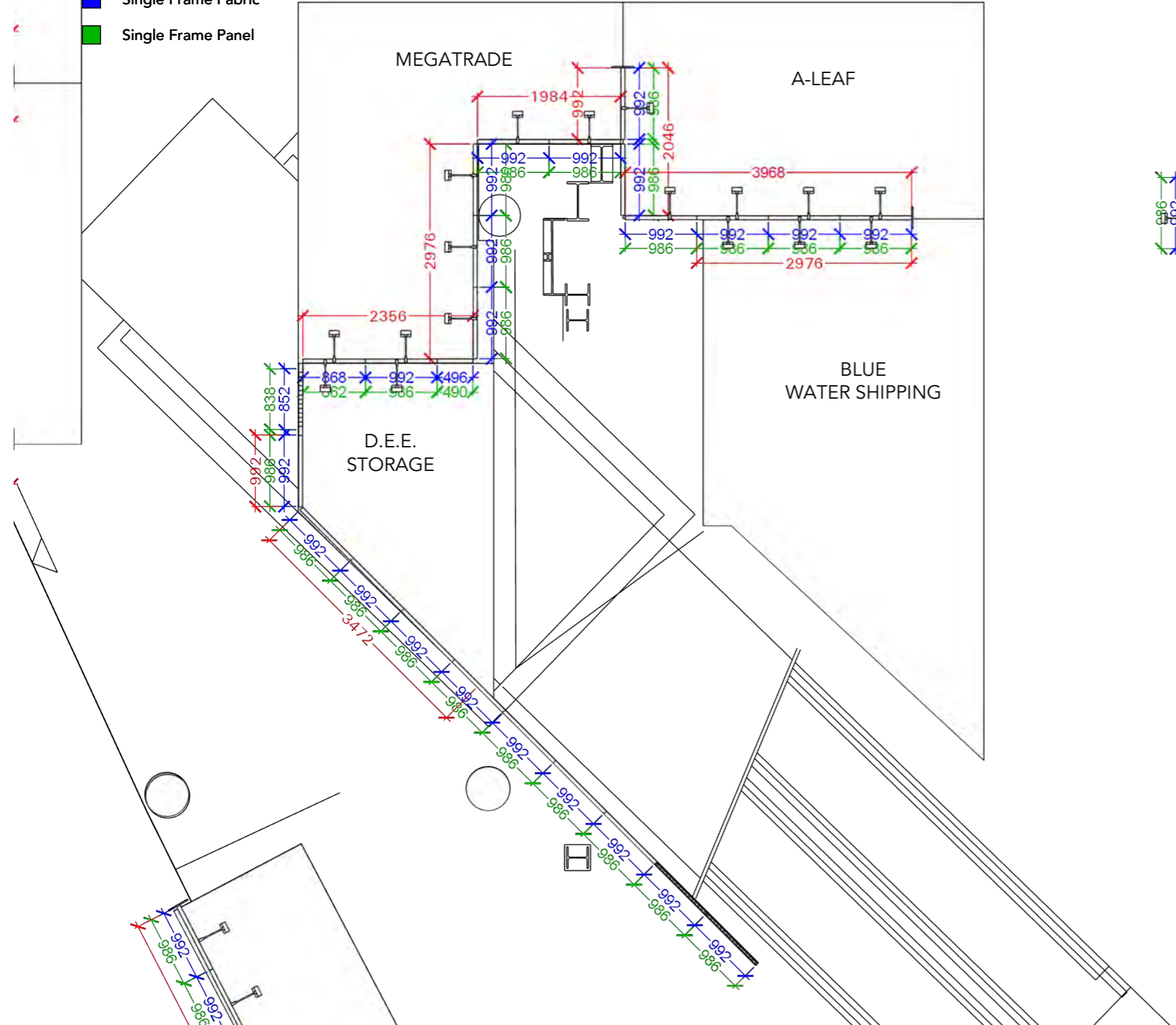

Graphics Dimensions - B1.EG

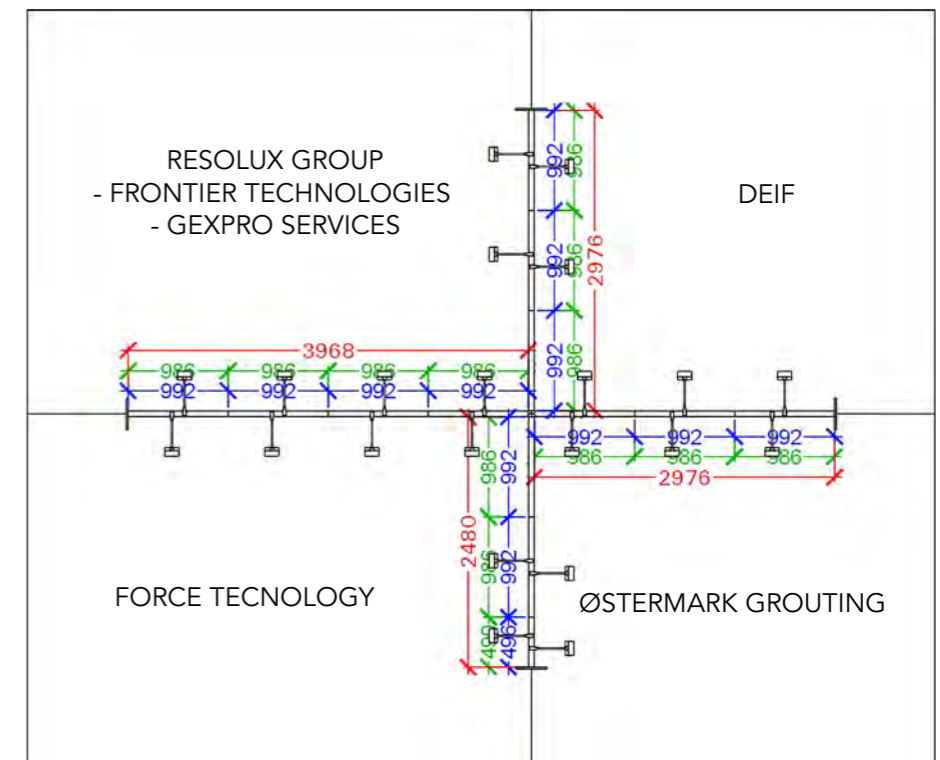
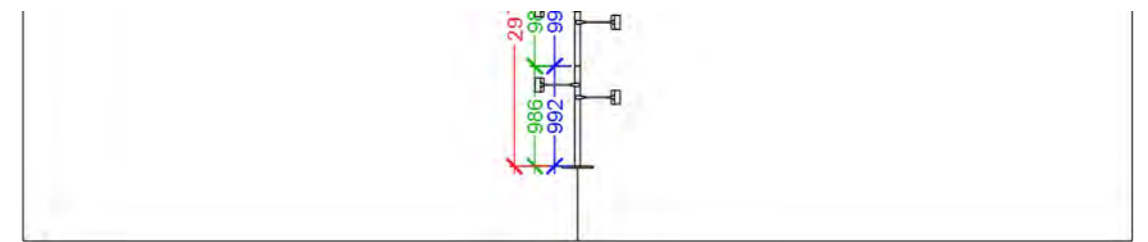
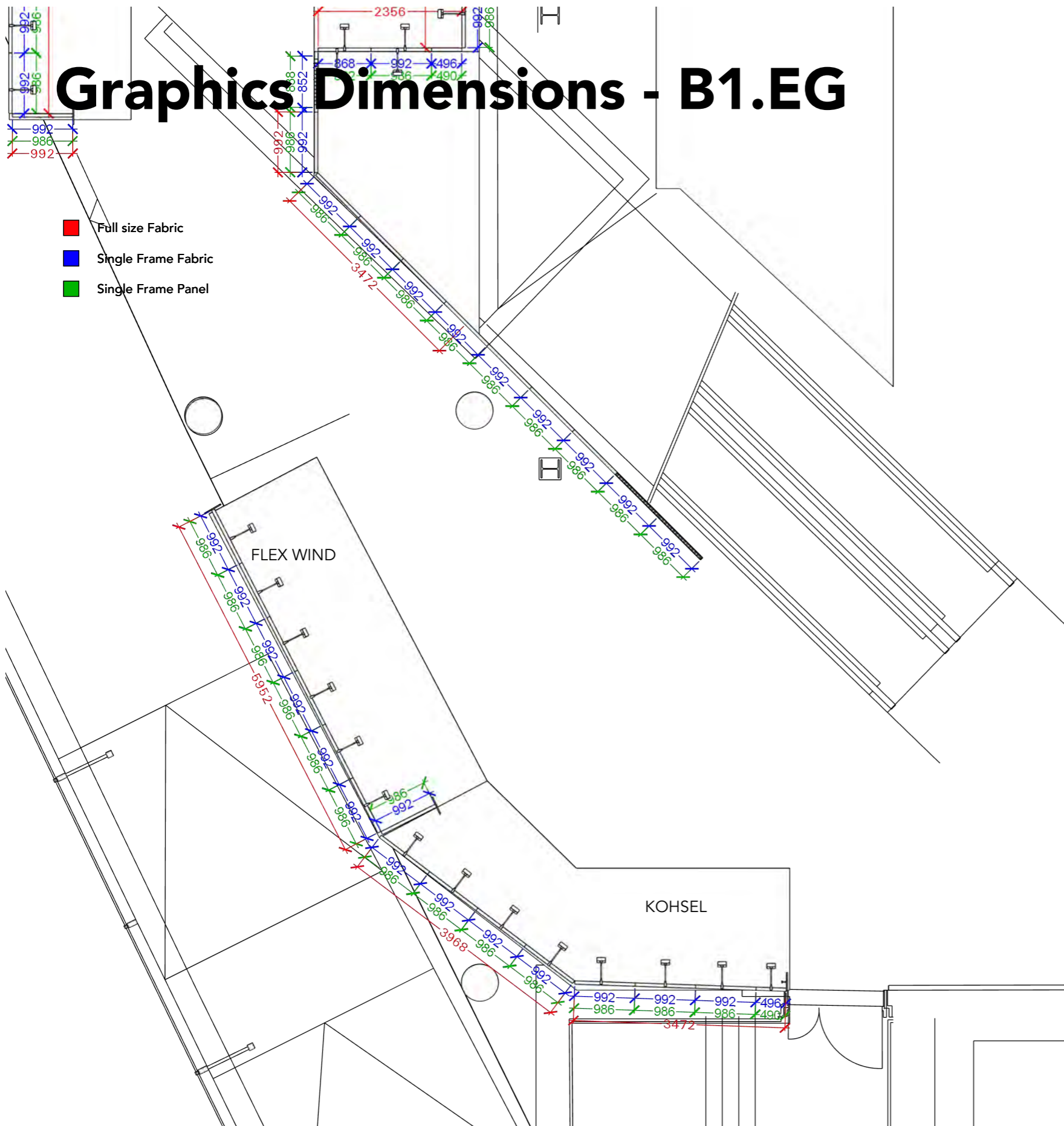

Graphics Dimensions - B1.EG

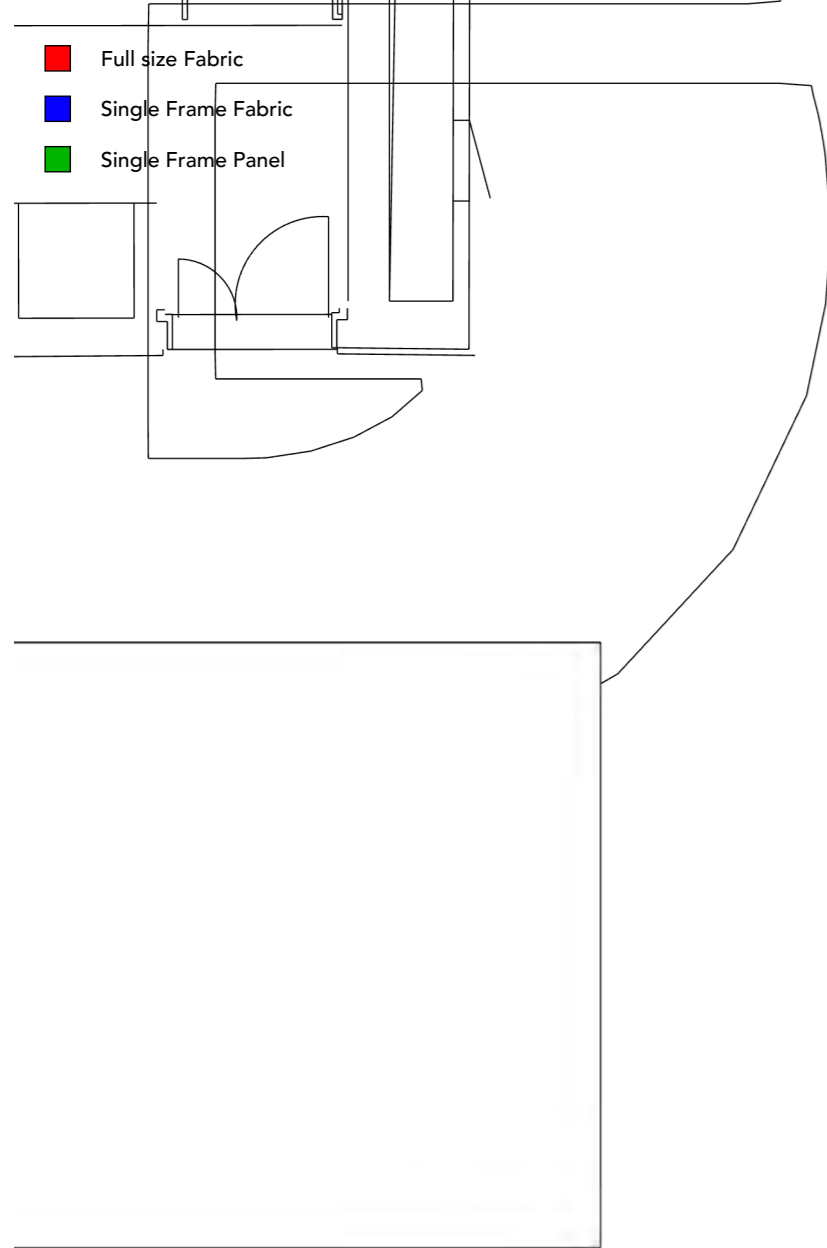
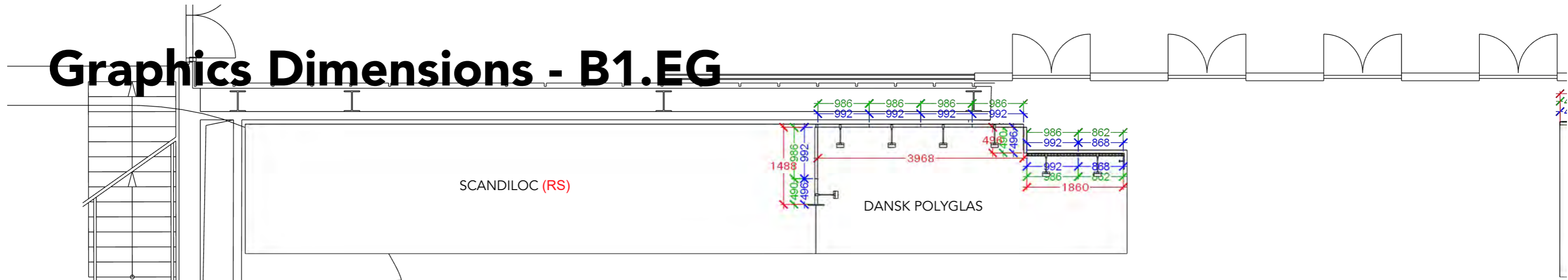

- Full size Fabric
- Single Frame Fabric
- Single Frame Panel

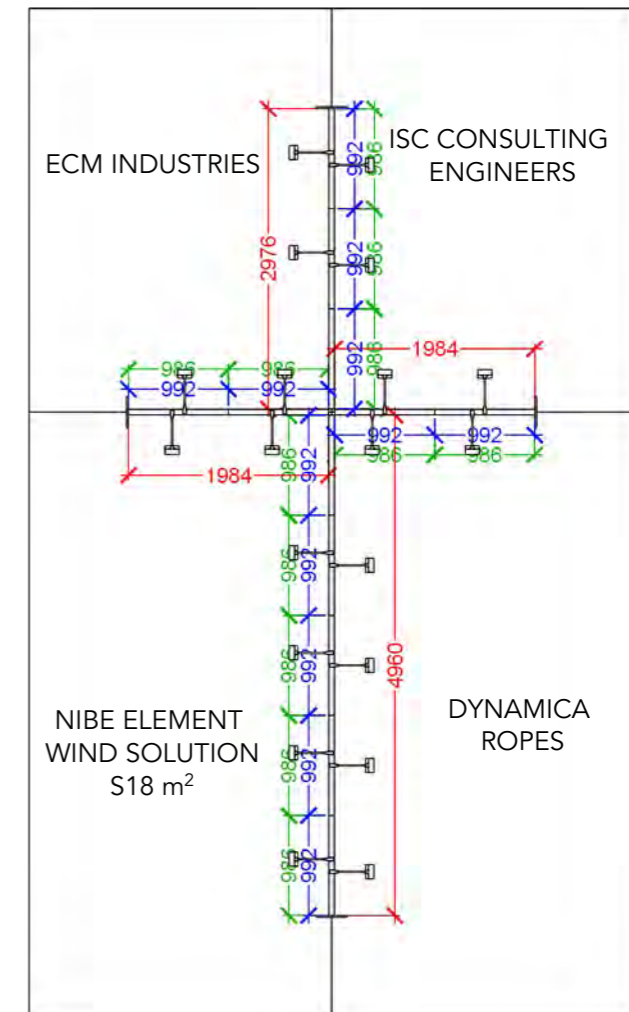
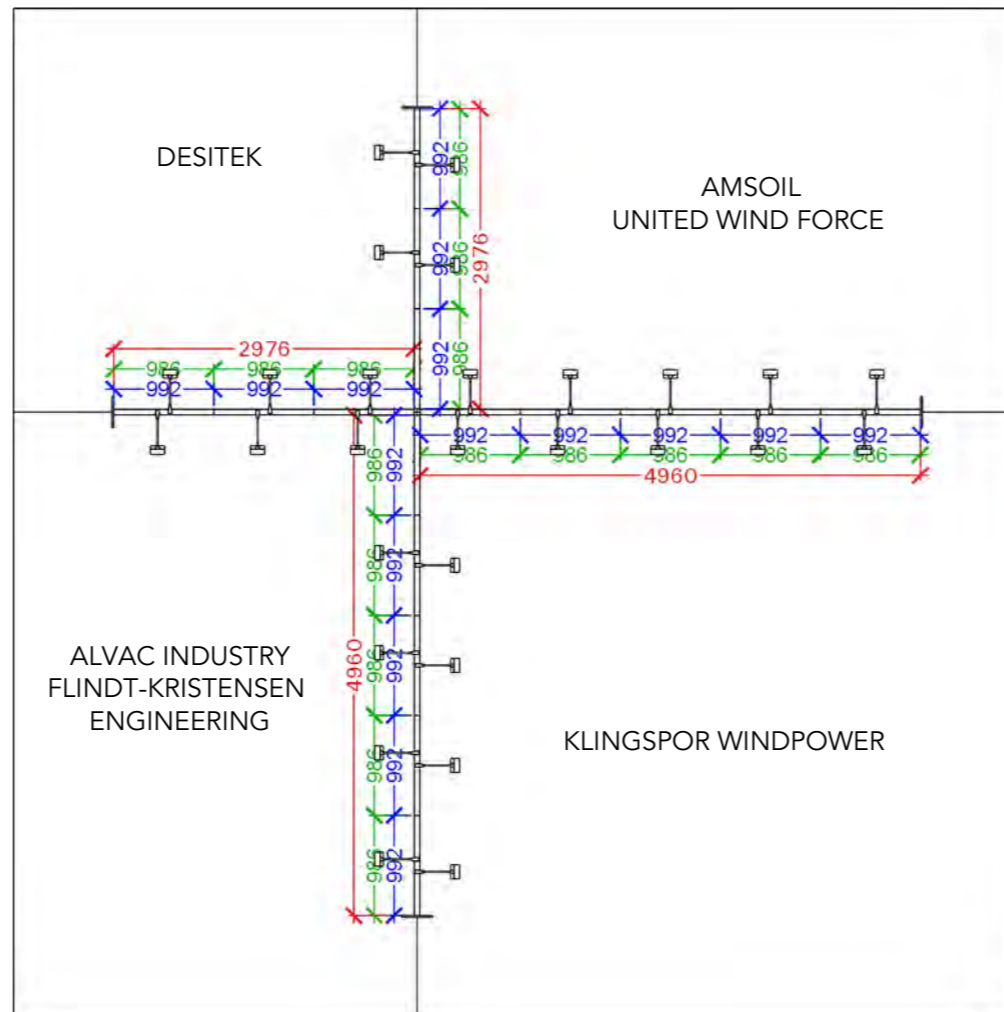

Graphics Dimensions - B1.EG

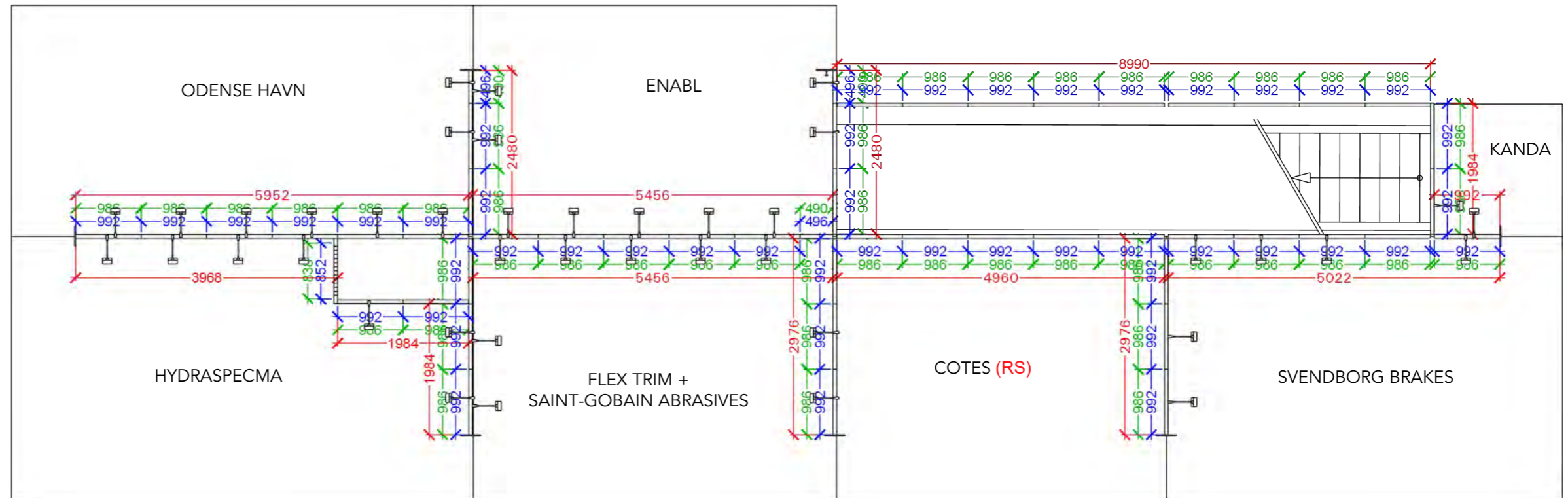
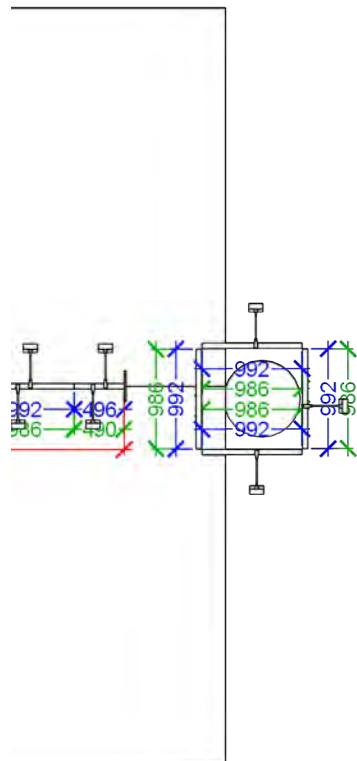
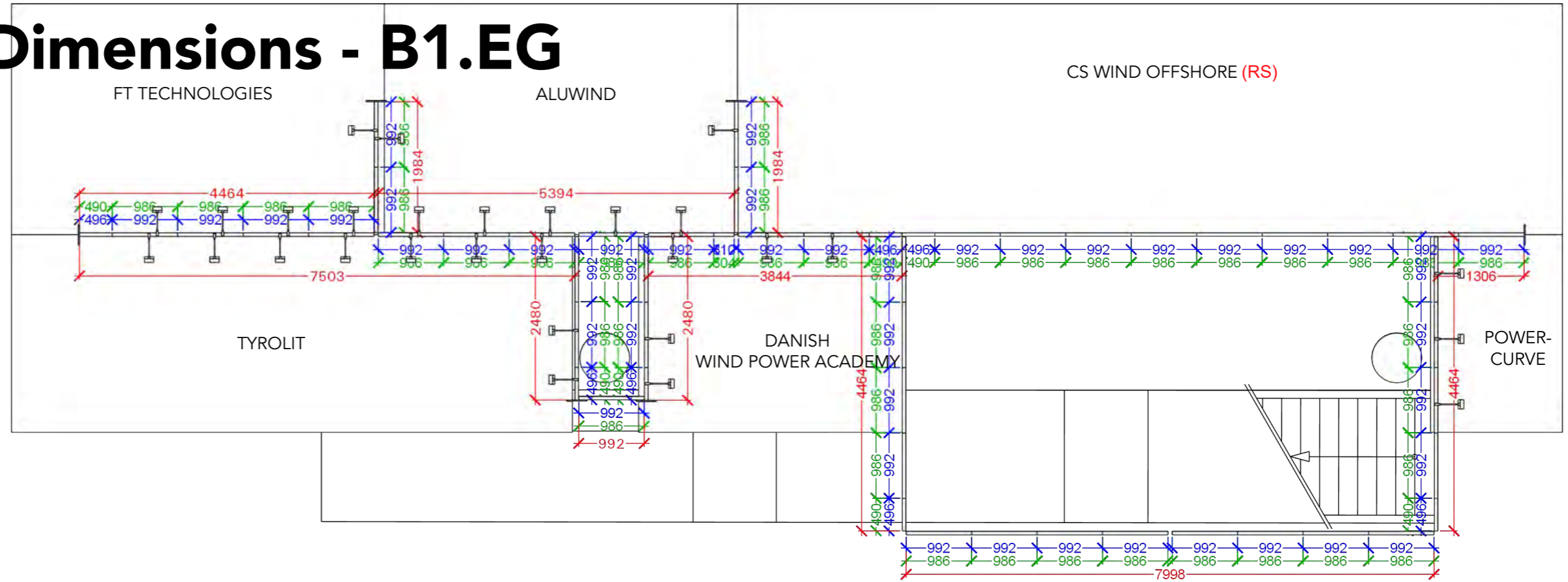
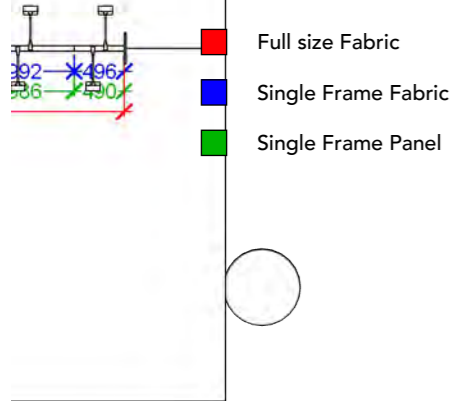

Graphics Dimensions - B1.EG

- Full size Fabric
- Single Frame Fabric
- Single Frame Panel

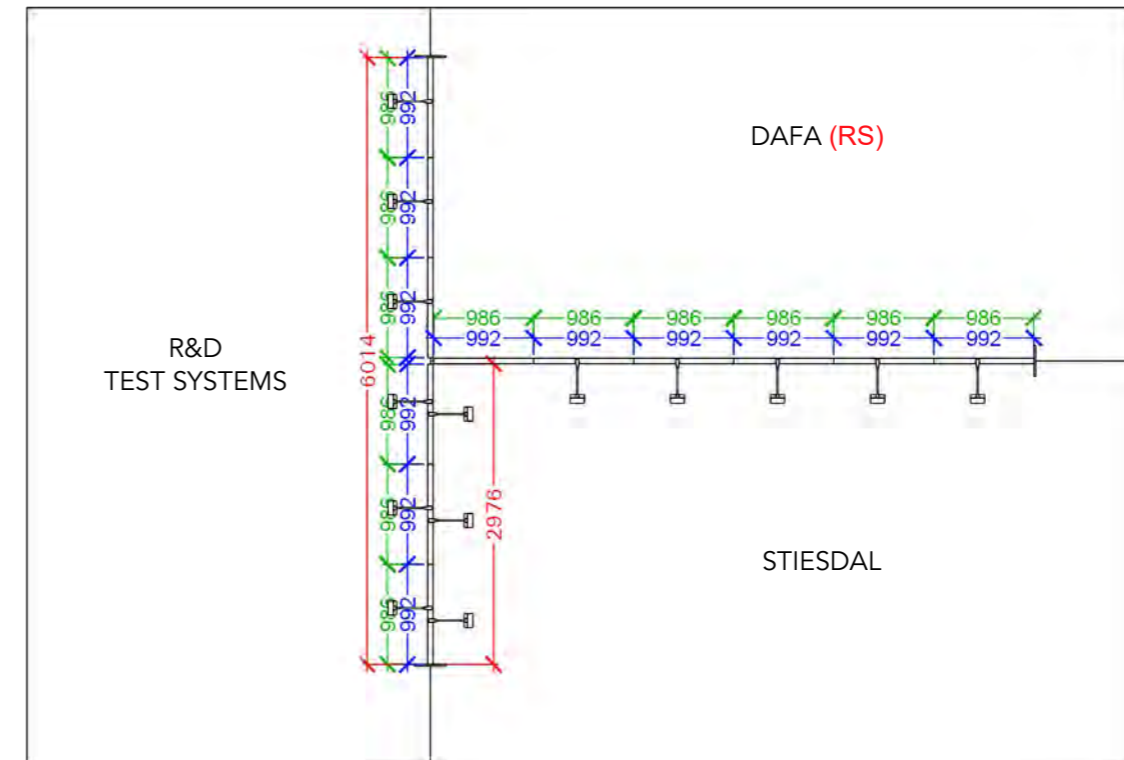
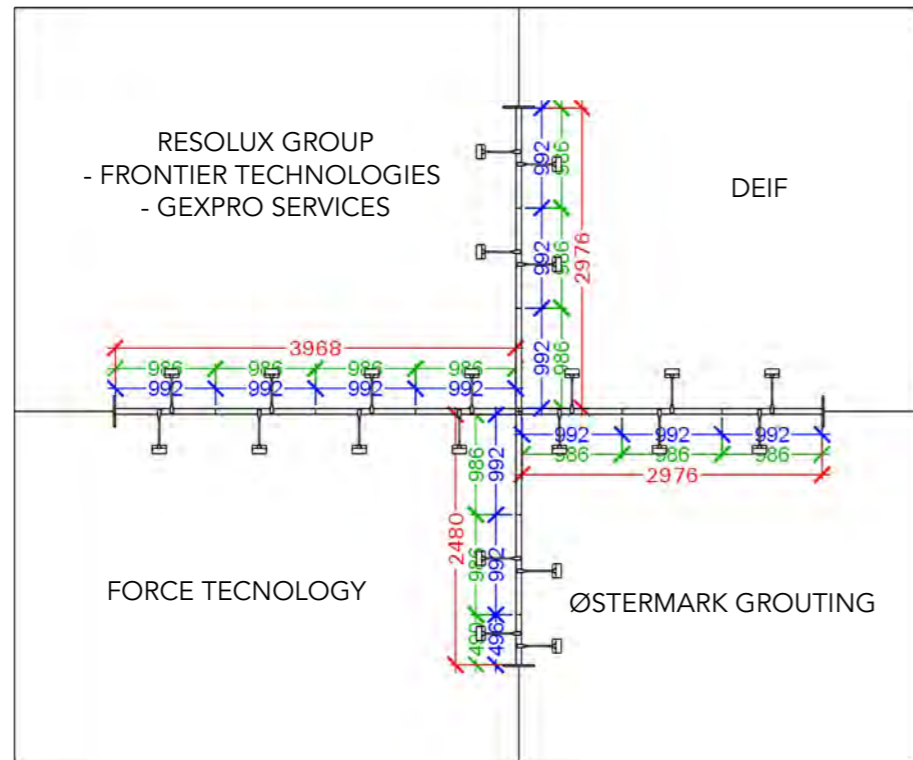

Graphics Dimensions - B1.EG

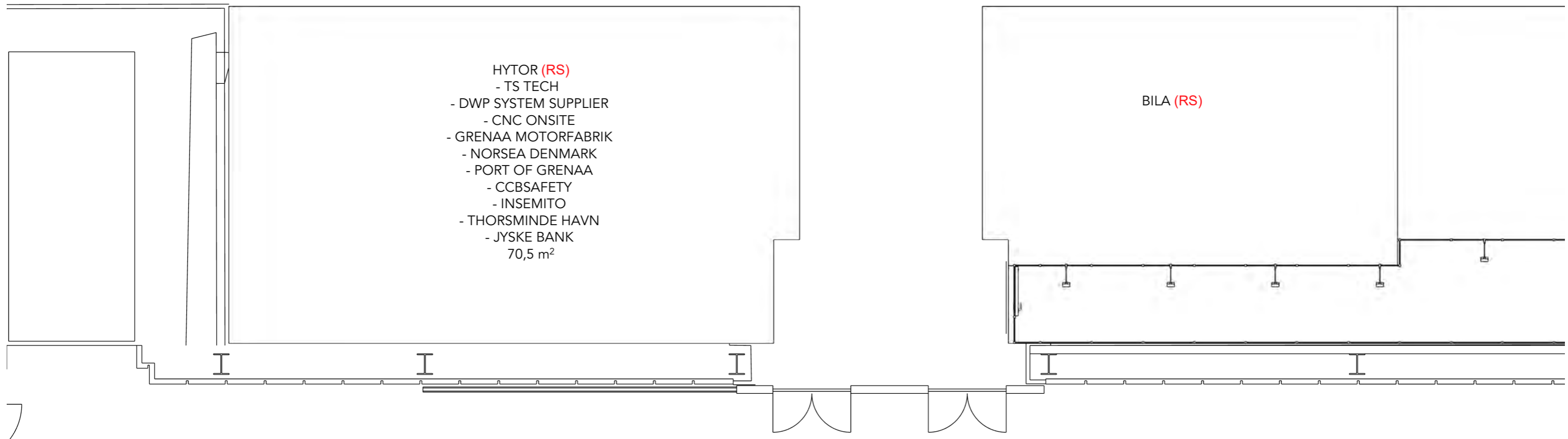
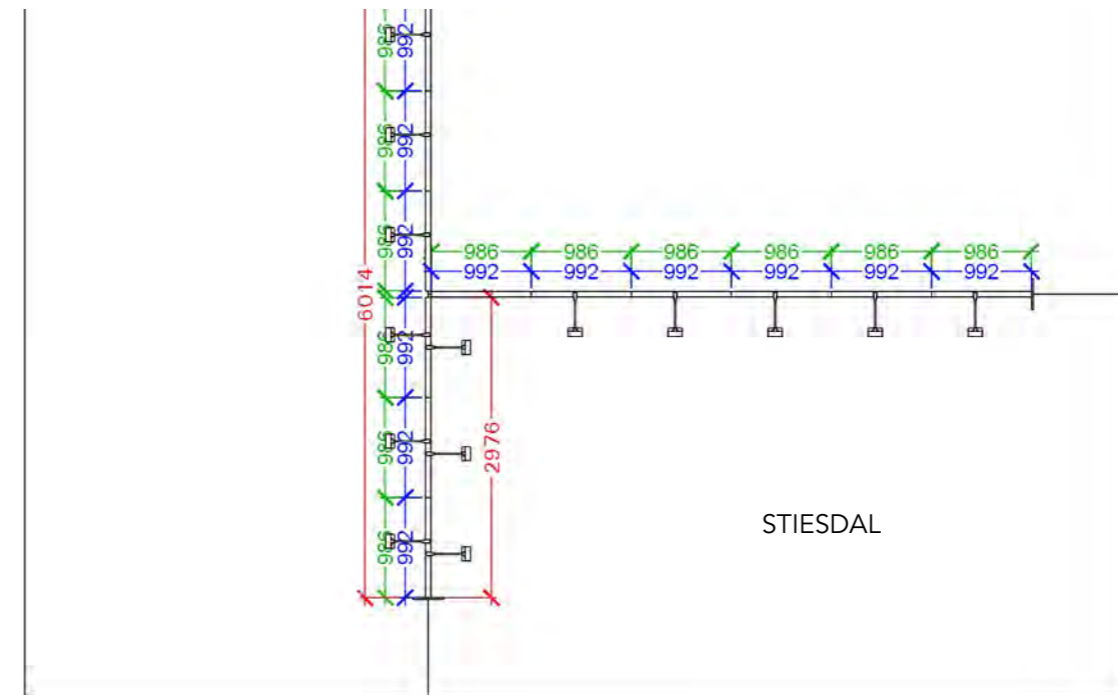
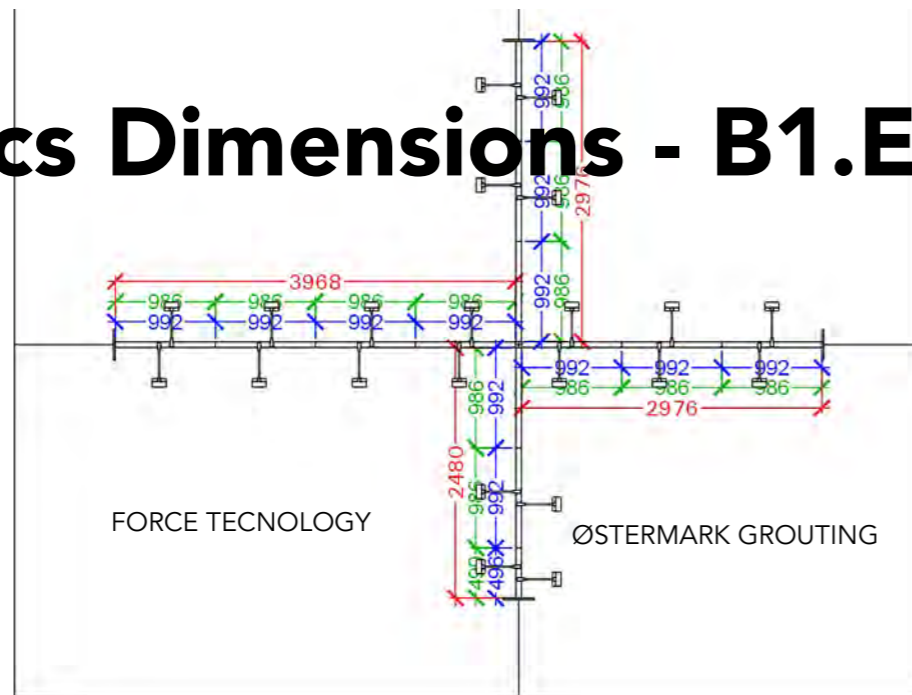
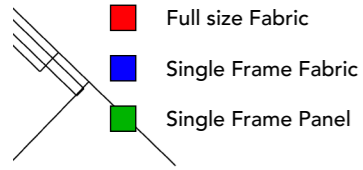

Graphics Dimensions - B1.EG

- Full size Fabric
- Single Frame Fabric
- Single Frame Panel

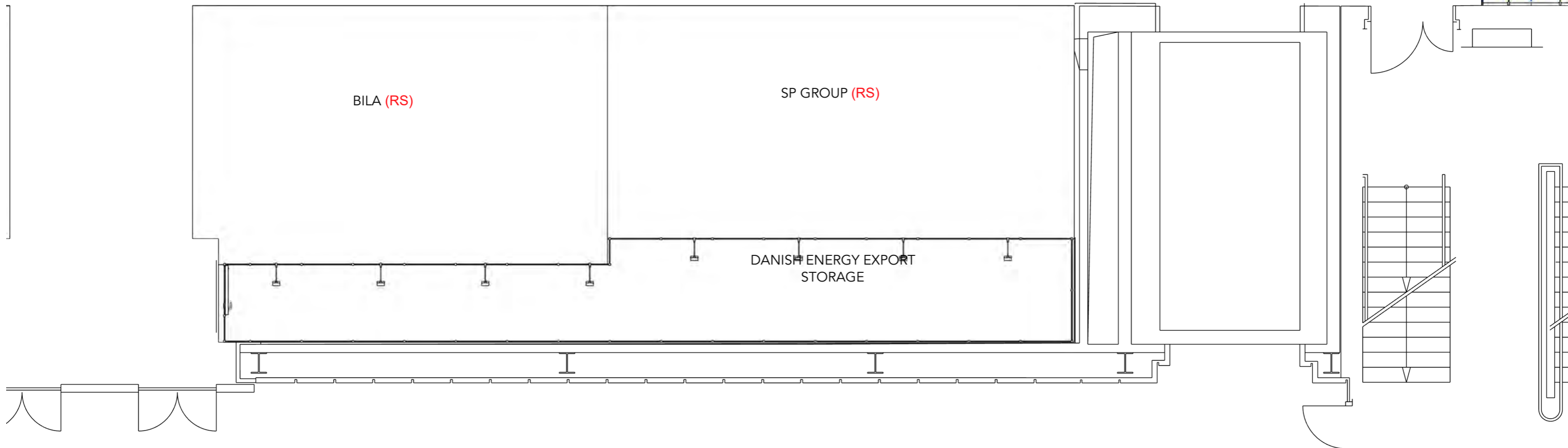
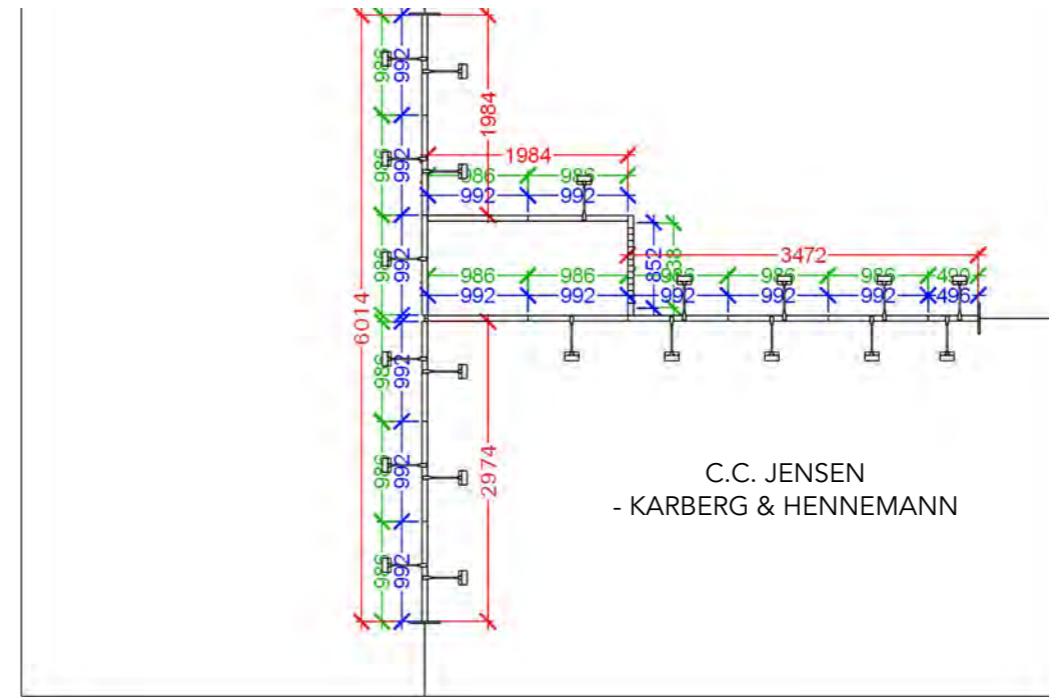
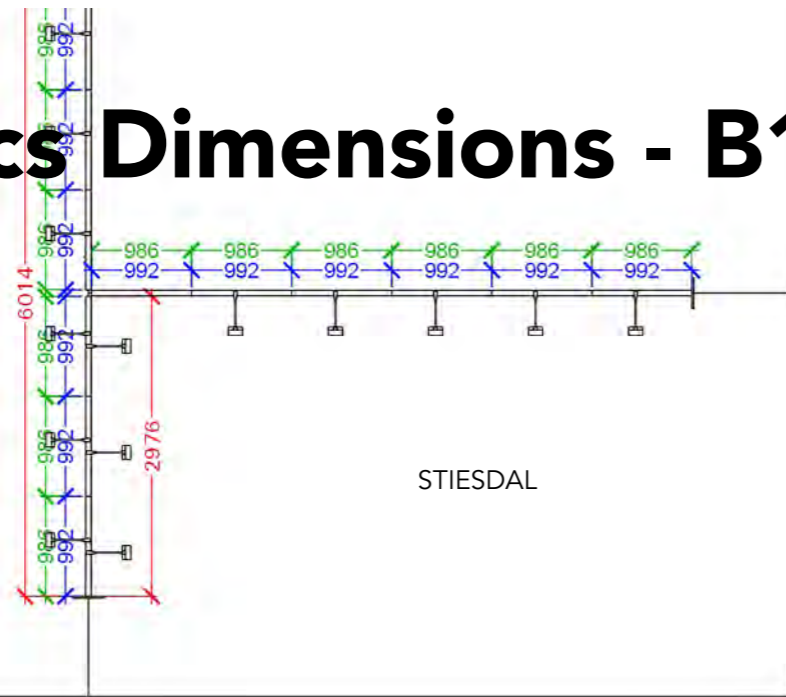

Graphics Dimensions - B1.EG

- Full size Fabric
- Single Frame Fabric
- Single Frame Panel

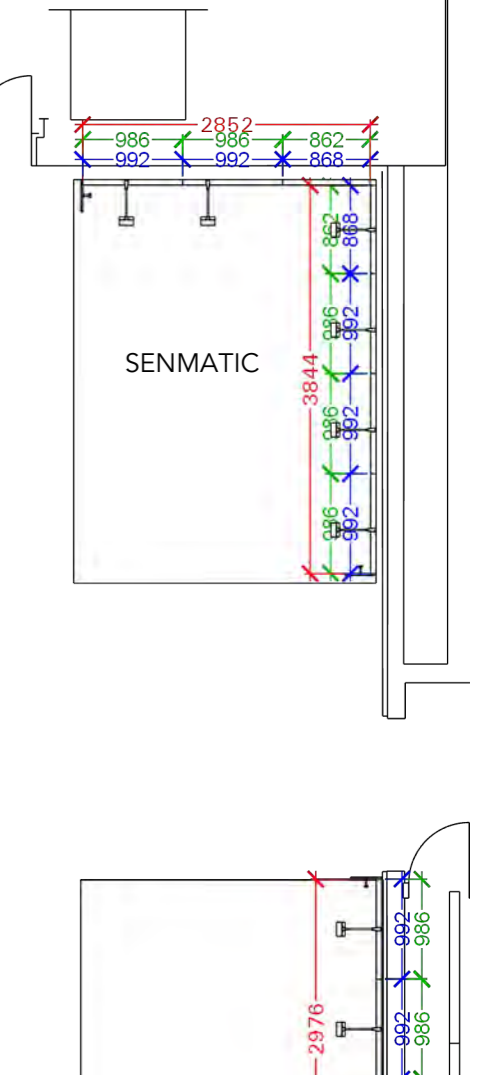
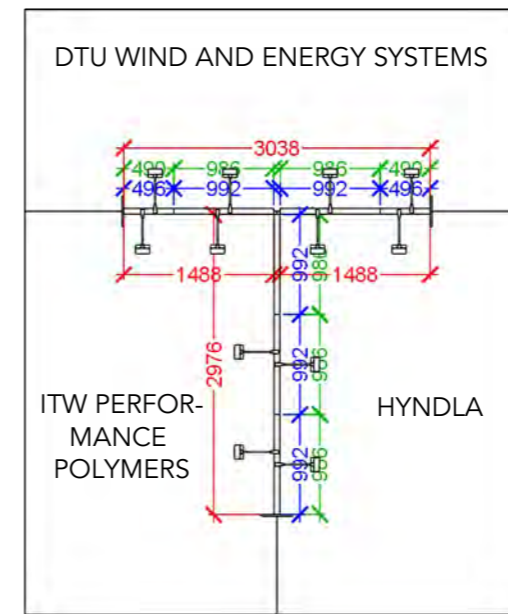
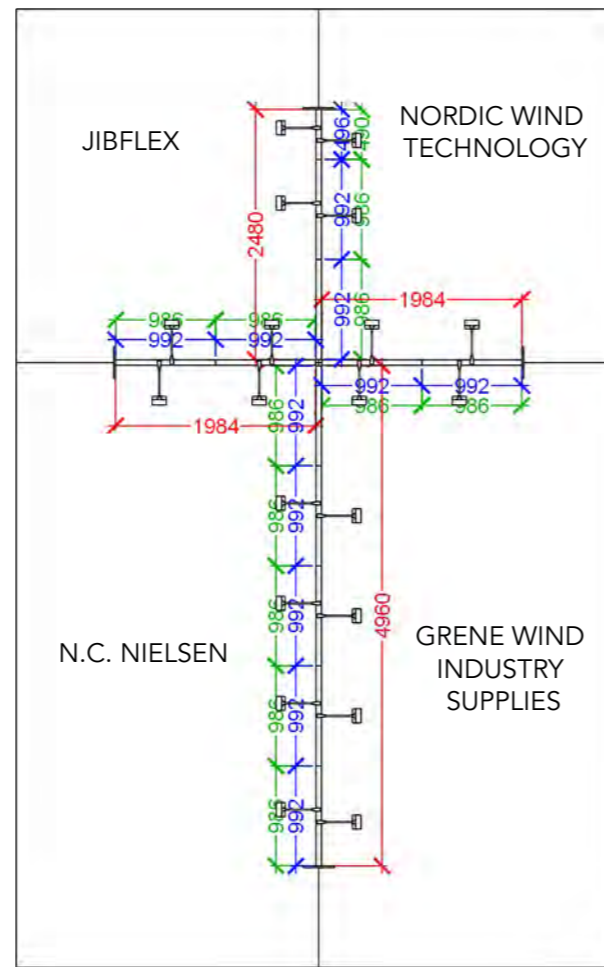
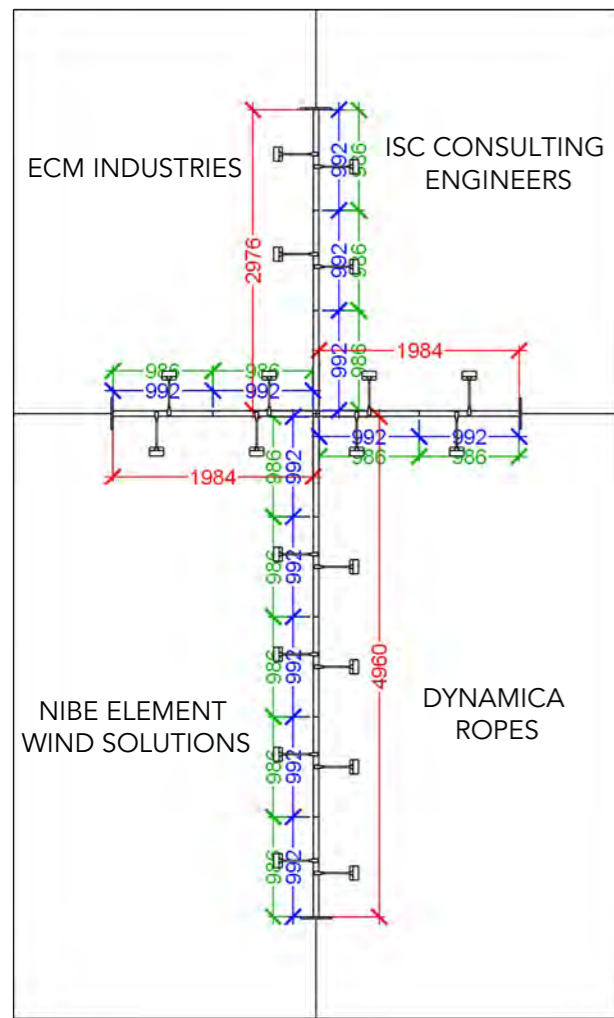
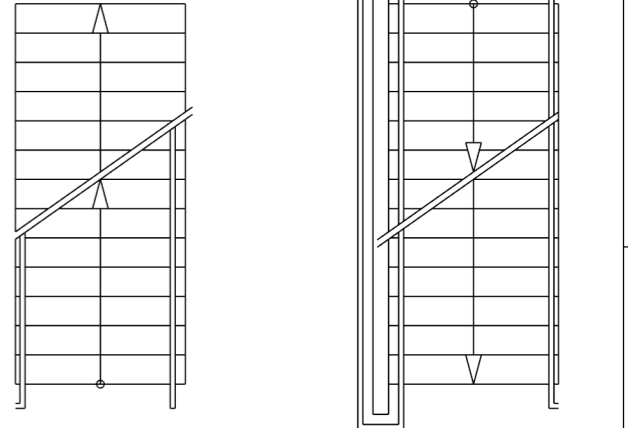
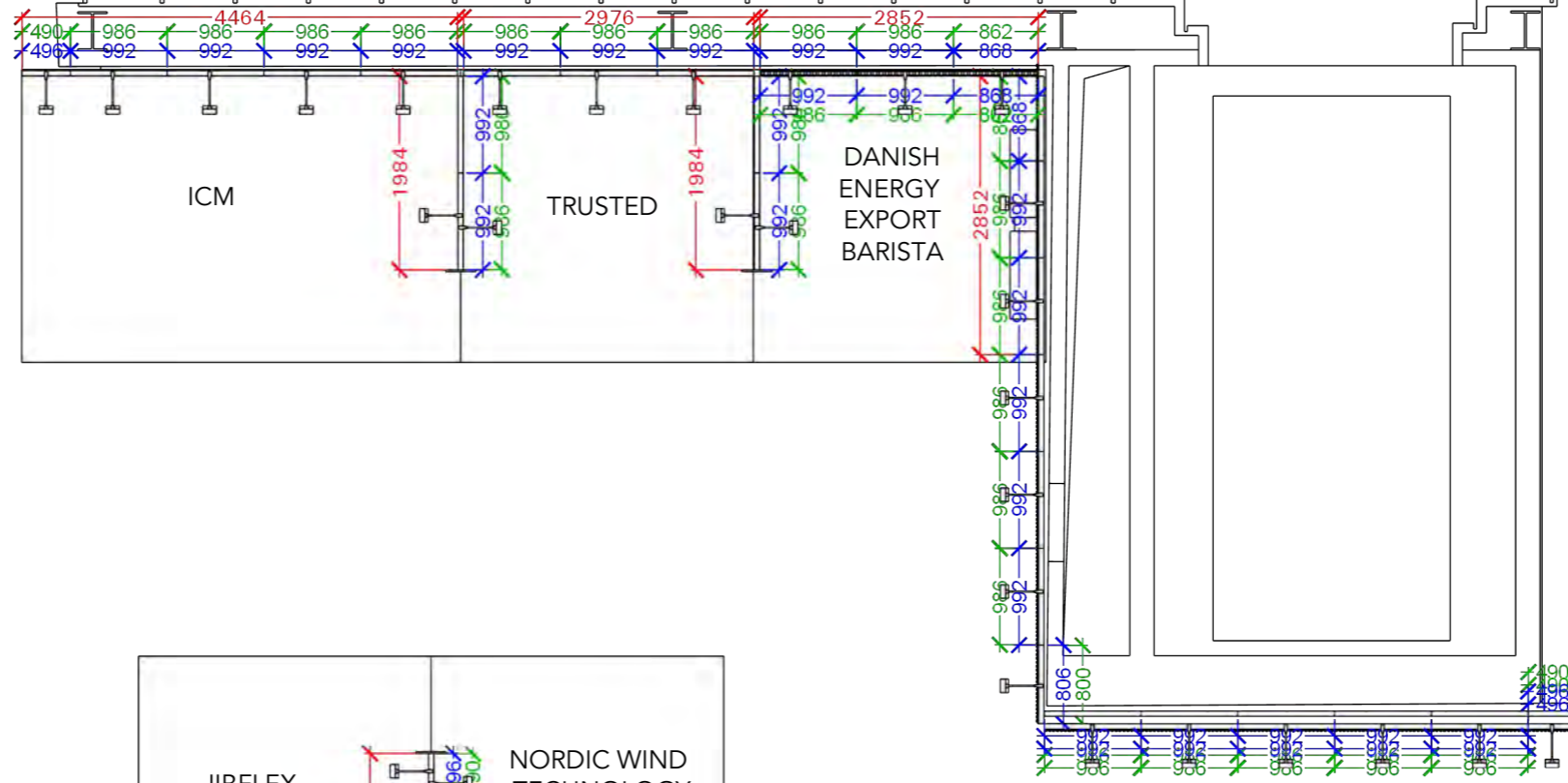

Graphics Dimensions - B1.EG

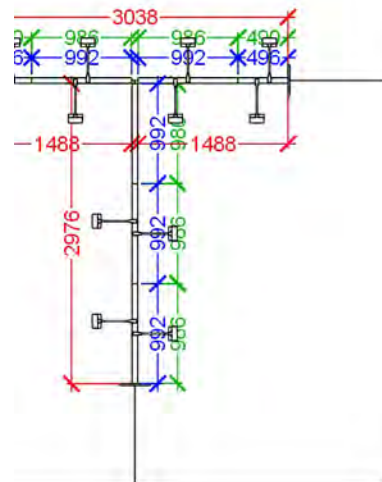

- Full size Fabric
- Single Frame Fabric
- Single Frame Panel

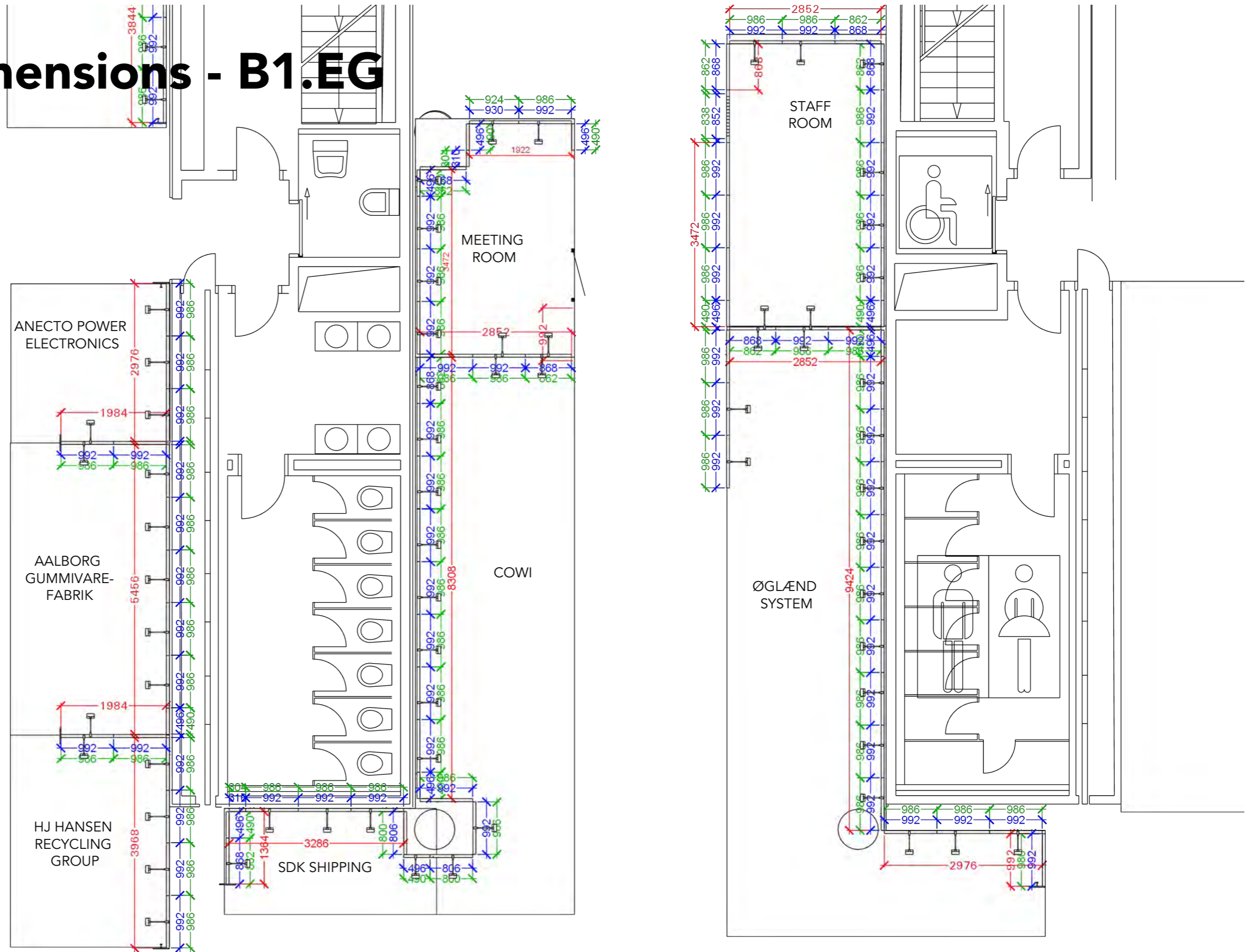
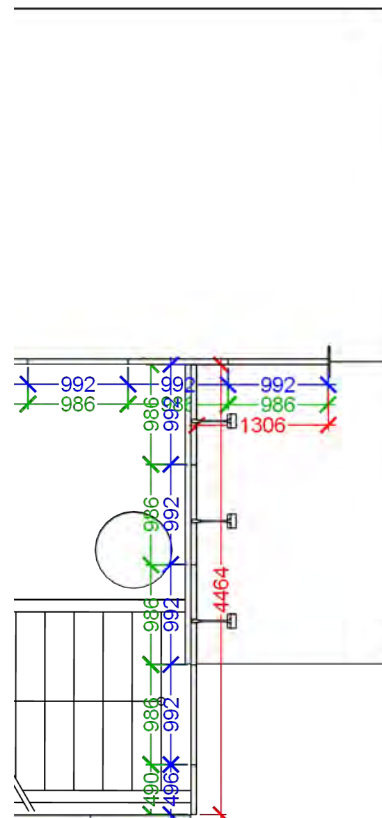

Client: Danish Energy Export
 Exhibition: WindEnergy Hamburg 2024

The drawing is indicative and without responsibility. The drawing is NOT to scale. The stand-builder will have the final call in all decisions regarding stability and security. Some products are only shown to indicate locations, but not the actual product as this product may be changed. All design is subject to copyright by Compass Fairs A/S and Standesign A/S

Project no.: EXP-WEN-24-09
 Designed By: SFT + SMM + THJ
 Hall: B1.EG + B2.EG
 Booth: Multiple

Creation Date: 11.01.2024
 Revision Date: 28.08.2024
 Revision no.: Z

Graphics Dimensions - B1.EG

- Full size Fabric
- Single Frame Fabric
- Single Frame Panel

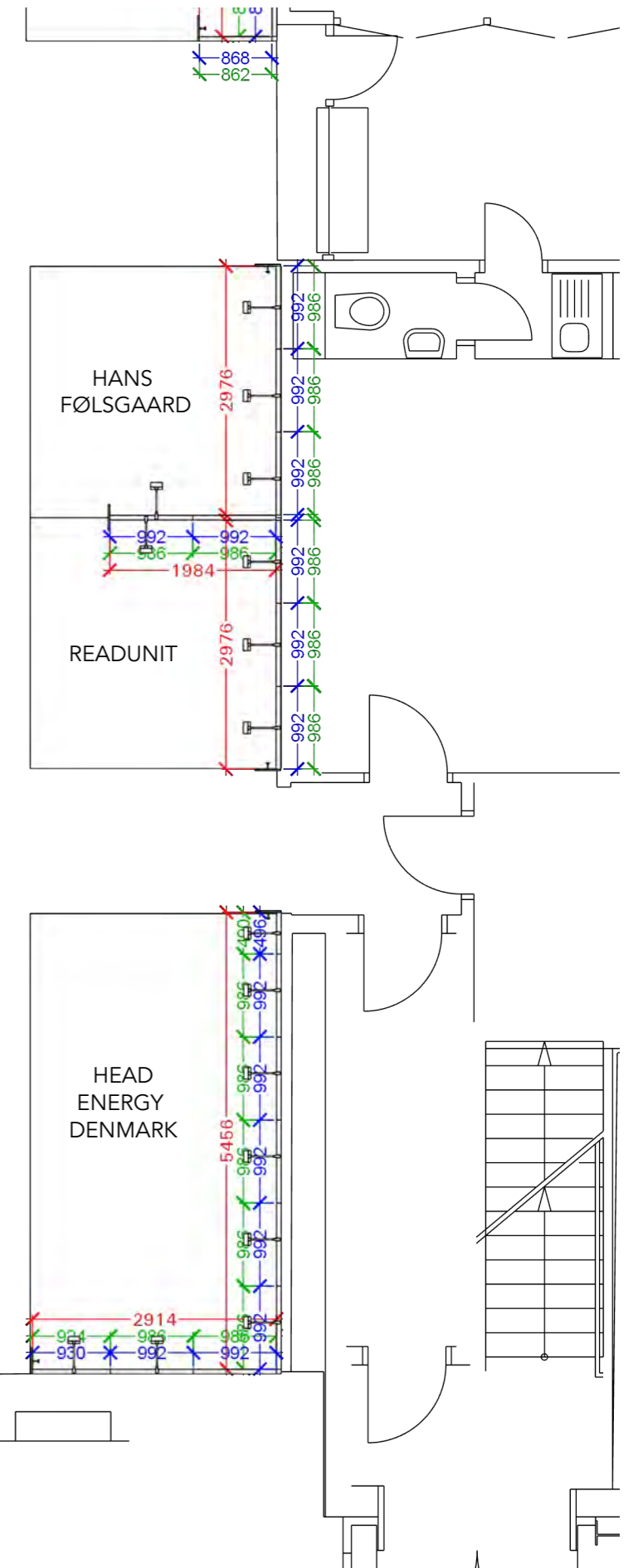
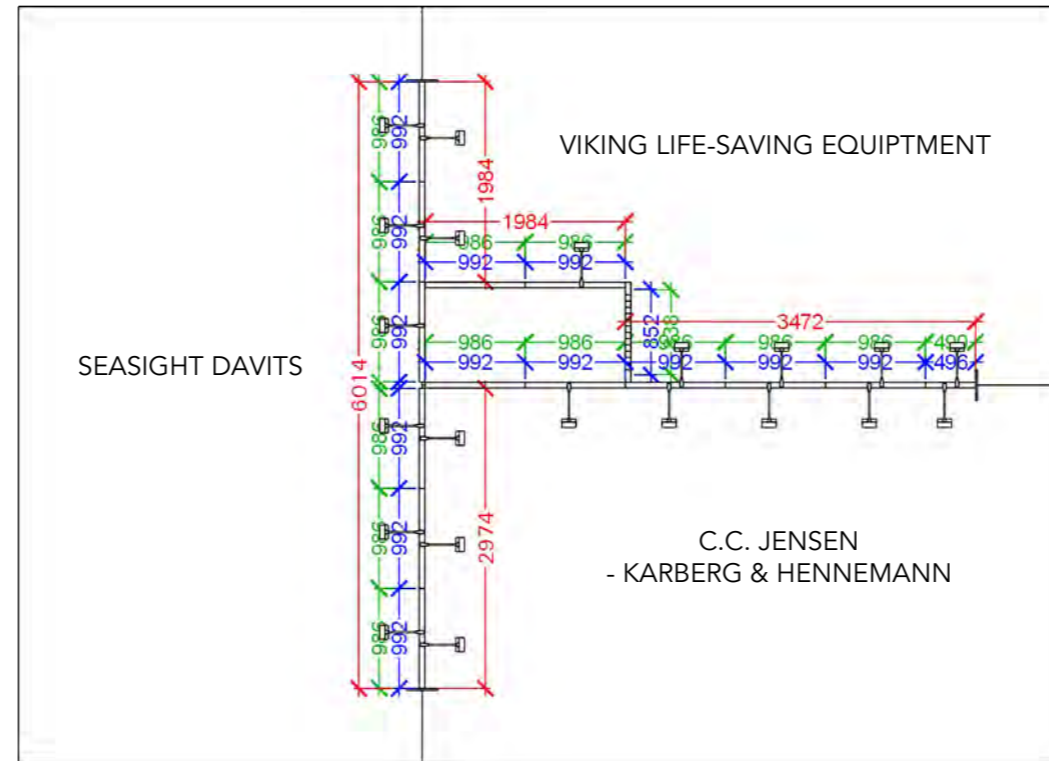
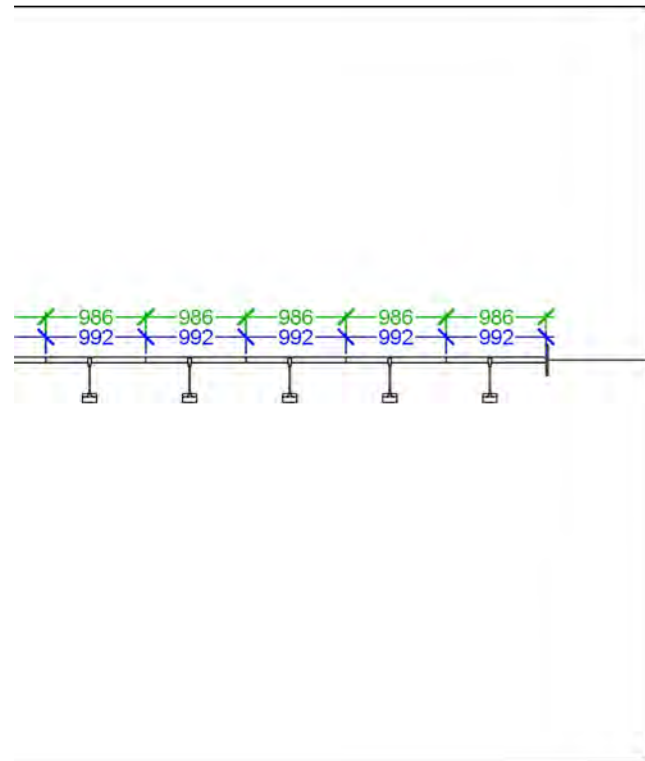

Graphics Dimensions - B2.EG

- Full size Fabric
- Single Frame Fabric
- Single Frame Panel

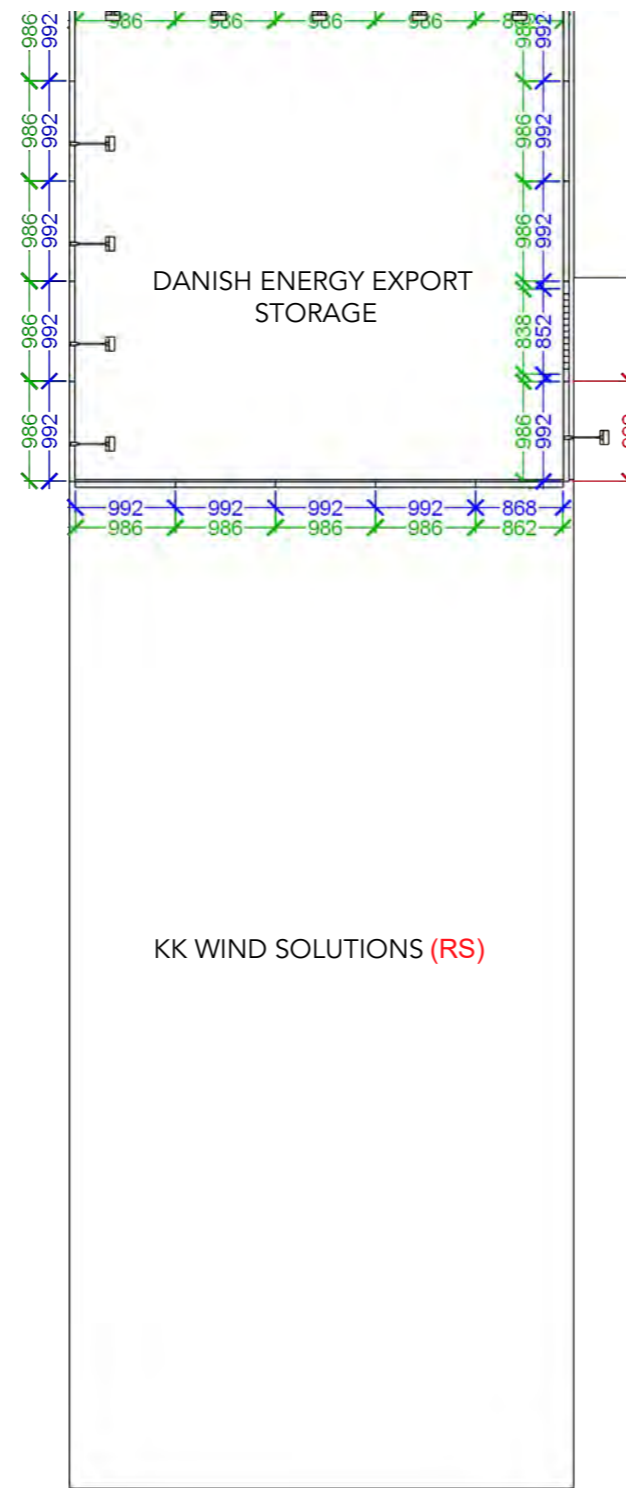
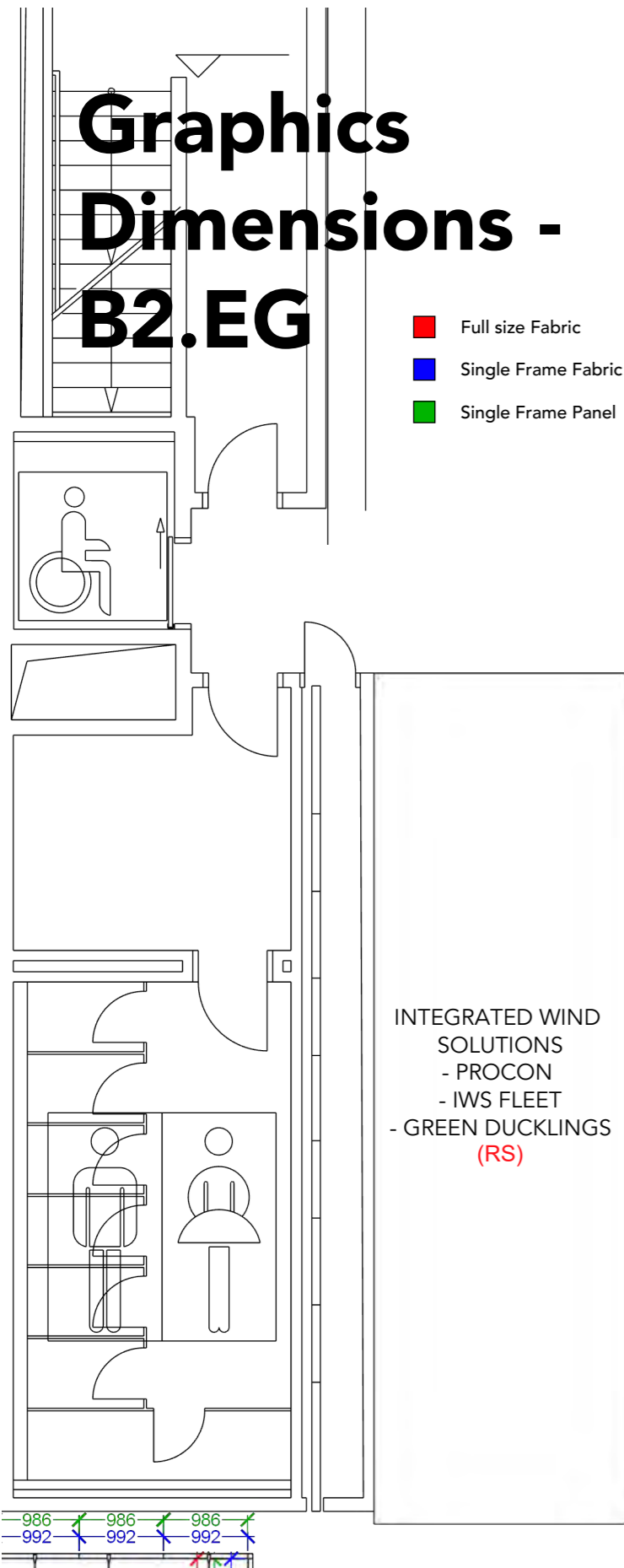

ZITON (RS)

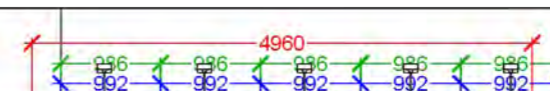
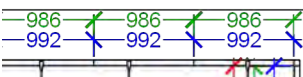
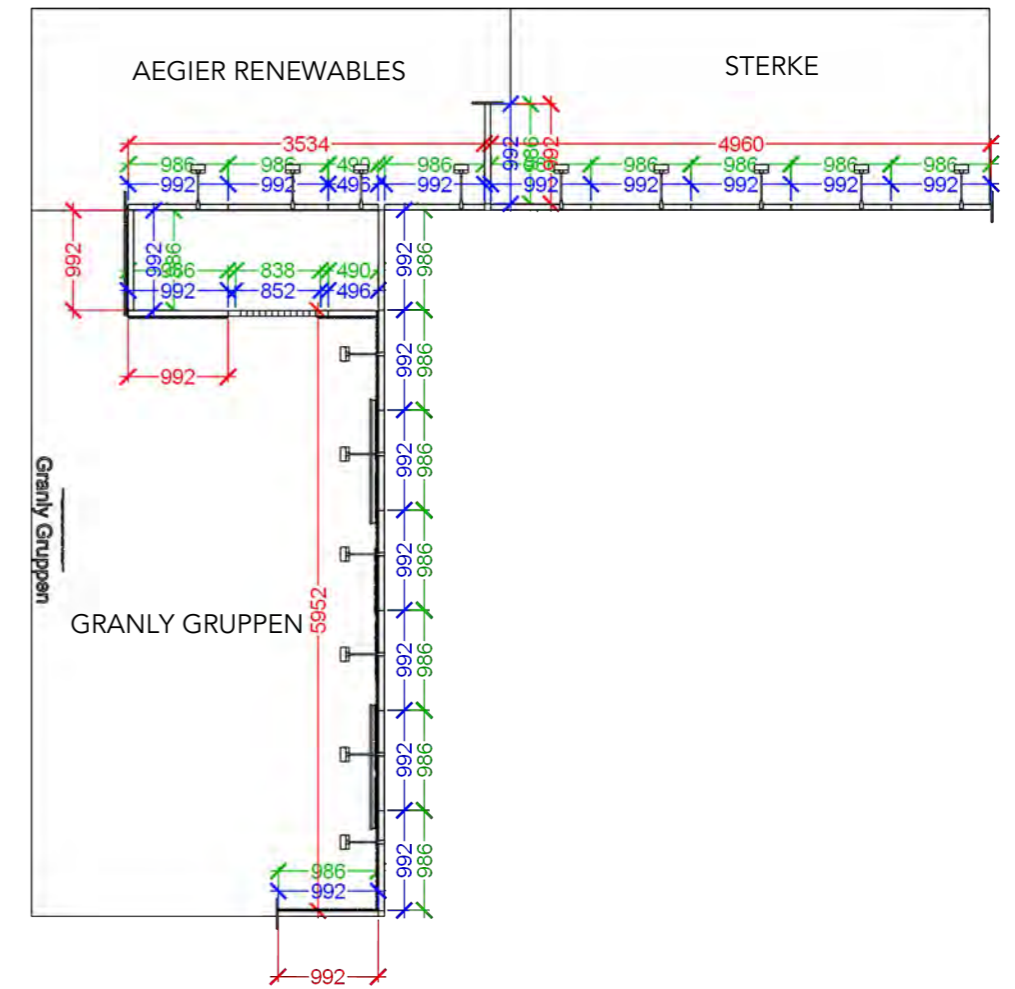

Graphics Dimensions - B2.EG

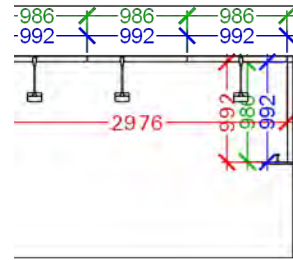
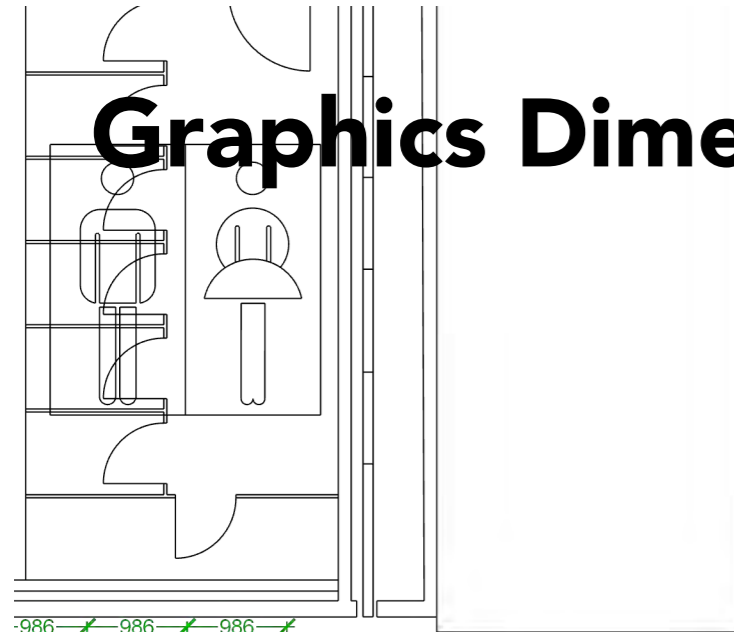

- Full size Fabric
- Single Frame Fabric
- Single Frame Panel

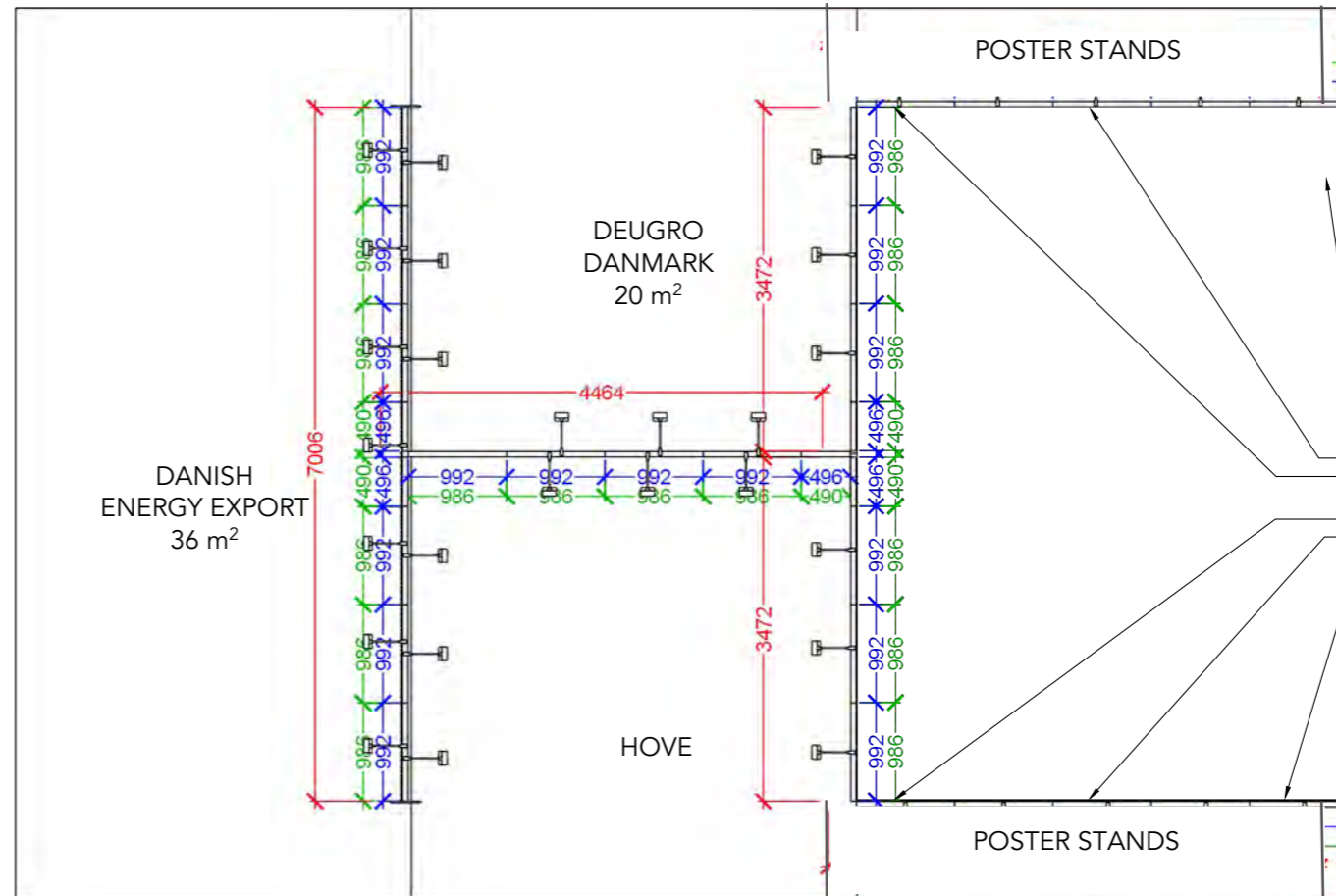
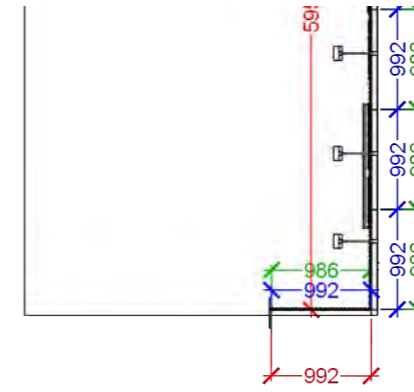
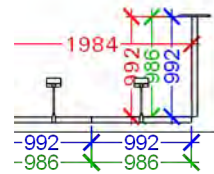
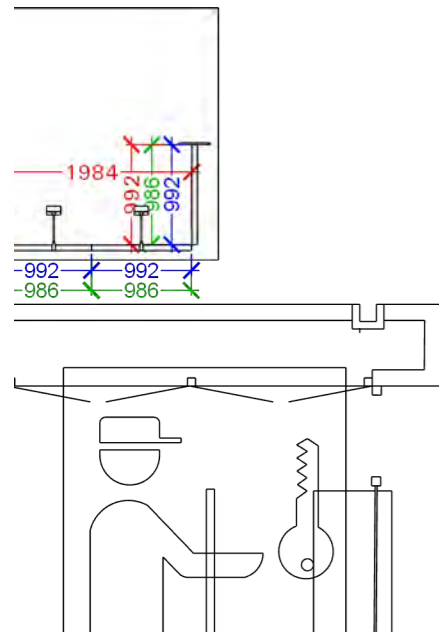

- VENTO MARITIME GRAPHICS - 1276 X 2380
- VENTOCO GRAPHICS - 1276 X 2380
- HARCO HEAVY LIFTING GRAPHICS - 1276 X 2380
- SCANEL INTERNATIONAL GRAPHICS - 1276 X 2380
- JUMBO CONSULTING GRAPHICS - 1276 X 2380
- NEWPARTS-SPAREPARTS BY DYMATEC GRAPHICS - 1276 X 2380

Info

Client: Danish Energy Export
Exhibition: WindEnergy Hamburg 2024

Project no.: EXP-WEN-24-09
Designed By: SFT + SMM + THJ
Hall: B1.EG + B2.EG
Booth: Multible

Creation Date: 11.01.2024
Revision Date: 28.08.2024
Revision no.: Z

Comments:

The drawing is indicative and without responsibility. The drawing is NOT to scale. The stand-builder will have the final call in all decisions regarding stability and security. Some products are only shown to indicate locations, but not the actual product as this product may be changed.
All design is subject to copyright by Compass Fairs A/S and Standesign A/S

