



## FURNITURE CATALOGUE PAVILION OF DENMARK



✓ RÅDGIVNING / ✓ DESIGN / ✓ HÅNDVÆRK / ✓ TEKNOLOGI

Nor-Fishing 2024  
20.08.2024 - 22.08.2024  
Trondheim Spektrum, Trondheim

# TABLE - STANDARD

Bord - Standard

## Description

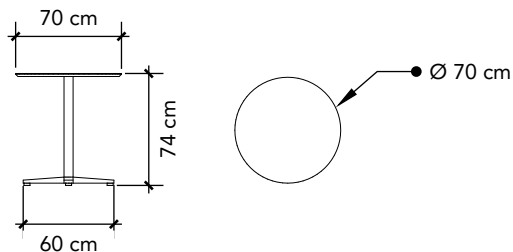

Table in suitable height for standard chairs.  
Table top is laminated.  
Stem and base are powder coated.



## Order Form Title:

- Table - Standard, white
- Table - Standard, black

## Colour:

-  White
-  Black

# TABLE - BAR

Bord - Barbord

## Description

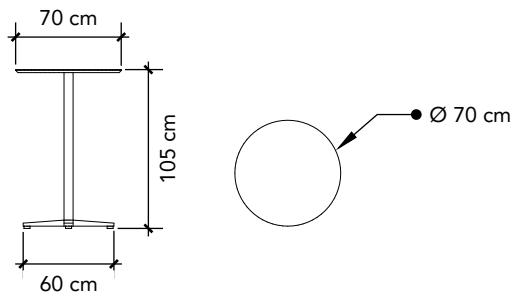

Table in suitable height for bar chairs or standing.  
Table top is laminated.  
Stem and base are powder coated.



## Order Form Title:

- Table - Bar, white
- Table - Bar, black

## Colour:

-  White
-  Black

# CHAIR - STANDARD

Stol - Standard

## Description

Chair with seat height suitable for standard table.  
The seat is laminated wood.  
Frame is in brushed steel.  
The chair is stackable.

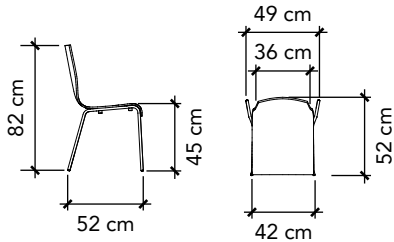

**Order Form Title:**  
- Chair - Standard, white

**Colour:**



White

# CHAIR - BAR

Stol - Barstol

## Description

Bar chair with seat height suitable for bar table.  
The seat is laminated wood.  
Frame is in brushed steel.  
The chair is stackable.

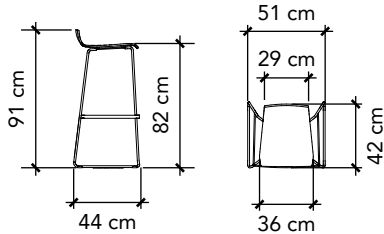
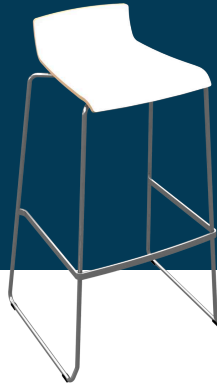

**Order Form Title:**  
- Chair - Bar, white

**Colour:**



# BROCHURE STAND - SWING-UP

Brochureholder - Swing-Up

## Description

Brochure stand in black powder-coated steel.  
There are 5 shelves with room for A4 brochures.

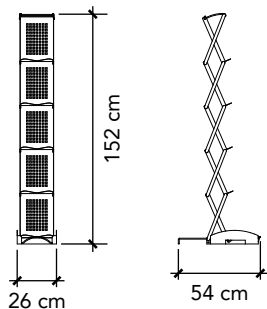

**Order Form Title:**  
- Brochure stand - Swing-Up, black

**Colour options:**



Black

# COUNTER - STANDARD

Info disk - Standard

## Description

Spray painted for smooth finish.  
Front can be fitted with printed surface.  
2 lockable cabinets at 60 cm and 40 cm width.  
1 shelf in each cabinet.

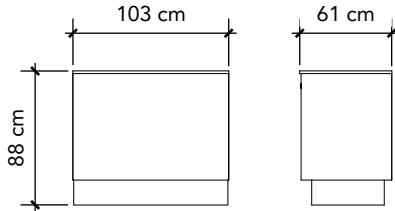

## Graphics Dimensions:

Front: W 1030 mm x H 704 mm

## Print INFO:

- Print ready PDF file  
(or logo in vector format (EPS or AI))
- Add 10 mm bleed
- All text must be outlined
- All images must be 100 dpi
- All colors will be printed in CMYK

## Order Form Title:

- Counter - Standard, white

## Colour:



# COUNTER - BAR TOP

Info disk med serveringstop

## Description

Spray painted for smooth finish.  
Front can be fitted with printed surface.  
2 lockable cabinets at 60 cm and 40 cm width.  
1 shelf in each cabinet.

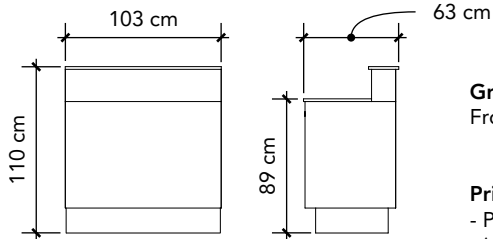

## Graphics Dimensions:

Front: W 1030 mm x H 917 mm

## Print INFO:

- Print ready PDF file  
(or logo in vector format (EPS or AI))
- Add 10 mm bleed
- All text must be outlined
- All images must be 100 dpi
- All colors will be printed in CMYK

## Order Form Title:

- Counter - Bar top, white

## Colour:





# COUNTER - OCTANORM

Info disk - Octanorm

## Description

Info counter made in our standard framing system.  
Front can be fitted with printed surface.  
Internal storage on a shelf.  
Sliding doors on back side.  
These doors are NOT lockable.

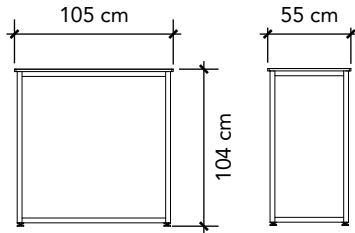
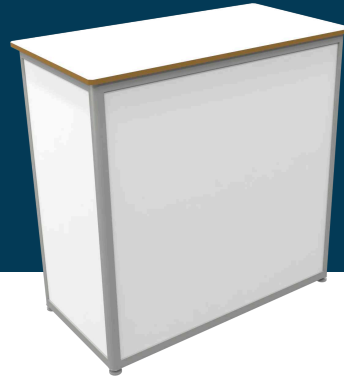

## Graphics Dimensions:

Front:

Panel size: W 964 mm x H 950 mm  
(Visible area: W 950 mm x H 936 mm)

## Print INFO:

- Print ready PDF file  
(or logo in vector format (EPS or AI))
- Add 10 mm bleed
- All text must be outlined
- All images must be 100 dpi
- All colors will be printed in CMYK

## Order Form Title:

- Counter - Octanorm system, white

## Colour:



# PODIUMS - STANDARD

Podie - Standard

## Description

Podium in a painted matte finish.  
Used for product display.  
All sides can be fitted with printed surface.  
Available in two different heights.

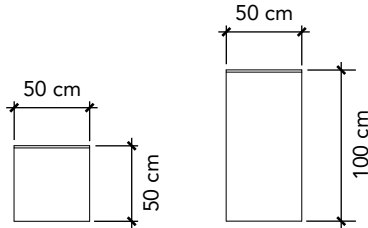
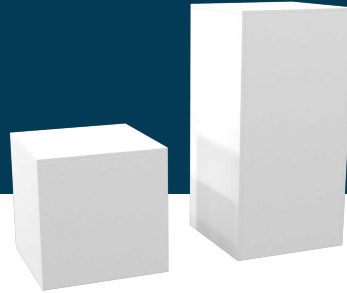

## Graphics Dimensions:

Low: W 2000 mm x H 500 mm

High: W 2000 mm x H 1000 mm

## Print INFO:

- Print ready PDF file  
(or logo in vector format (EPS or AI))
- Add 10 mm bleed
- All text must be outlined
- All images must be 100 dpi
- All colors will be printed in CMYK



## Order Form Title:

- Podium - Standard, low, white
- Podium - Standard, high, white

## Colour:



White

# PODIUM - CABINET

Podie - Skab

## Description

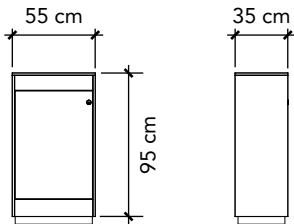

Podium with cabinet in a painted matte finish.  
Used for product display (or monitor).  
Lockable cabinet.  
1 shelf in cabinet.



## Order Form Title:

- Podium - Cabinet, white
- Podium - Cabinet, black

## Colour:

-  White
-  Black

# MONITORS - LED

Skærme - LED

## Description

Monitor of different brands and sizes.  
LED display screen.  
Used for videos or other media.  
Connection to PC possible - USB and HDMI ports.  
HDMI cable included.

Insurance included.

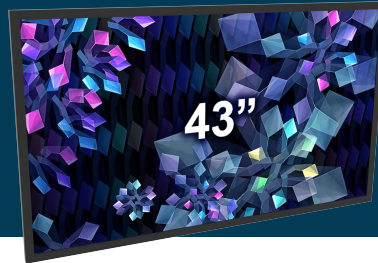
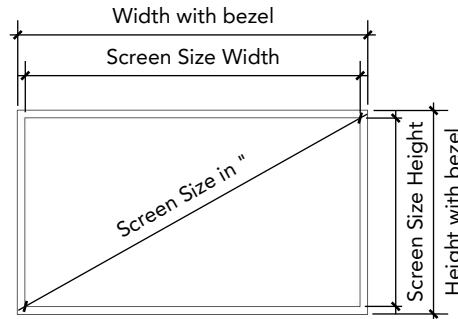

Image above is an example of a 43" monitor.

Size info (with bezel\*):

- 32" = W 708 x H 398 mm (768 x 458 mm)
- 43" = W 952 x H 535 mm (992 x 575 mm)
- 55" = W 1218 x H 685 mm (1258 x 725 mm)
- 65" = W 1440 x H 810 mm (1480 x 850 mm)
- 75" = W 1661 x H 935 mm (1701 x 975 mm)

\*Bezels varies from model to model.  
These are just approximate values.



**Order Form Title:**

- Monitor - LED - 32"
- Monitor - LED - 43"
- Monitor - LED - 55"
- Monitor - LED - 65"
- Monitor - LED - 75"

# MONITOR FLOOR STAND

Fod til skærm

## Description

Monitor floor stand for monitors up to 55".  
The base is galvanized cast iron.  
The stem is aluminum matte finish.

**Monitor NOT included.**

**Maximum height for top of monitor = 2 m**

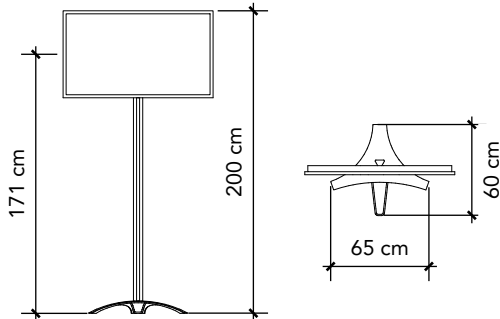
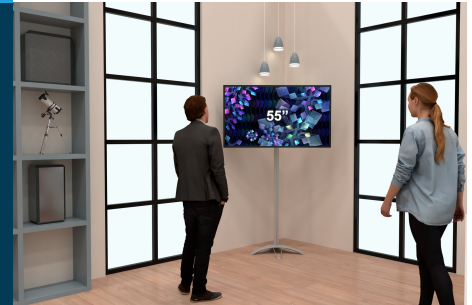

**Order Form Title:**

- Monitor floor stand

**Colour of stem + base:**



Metallic Gray