

IFAT 2024

# Danish Energy Export

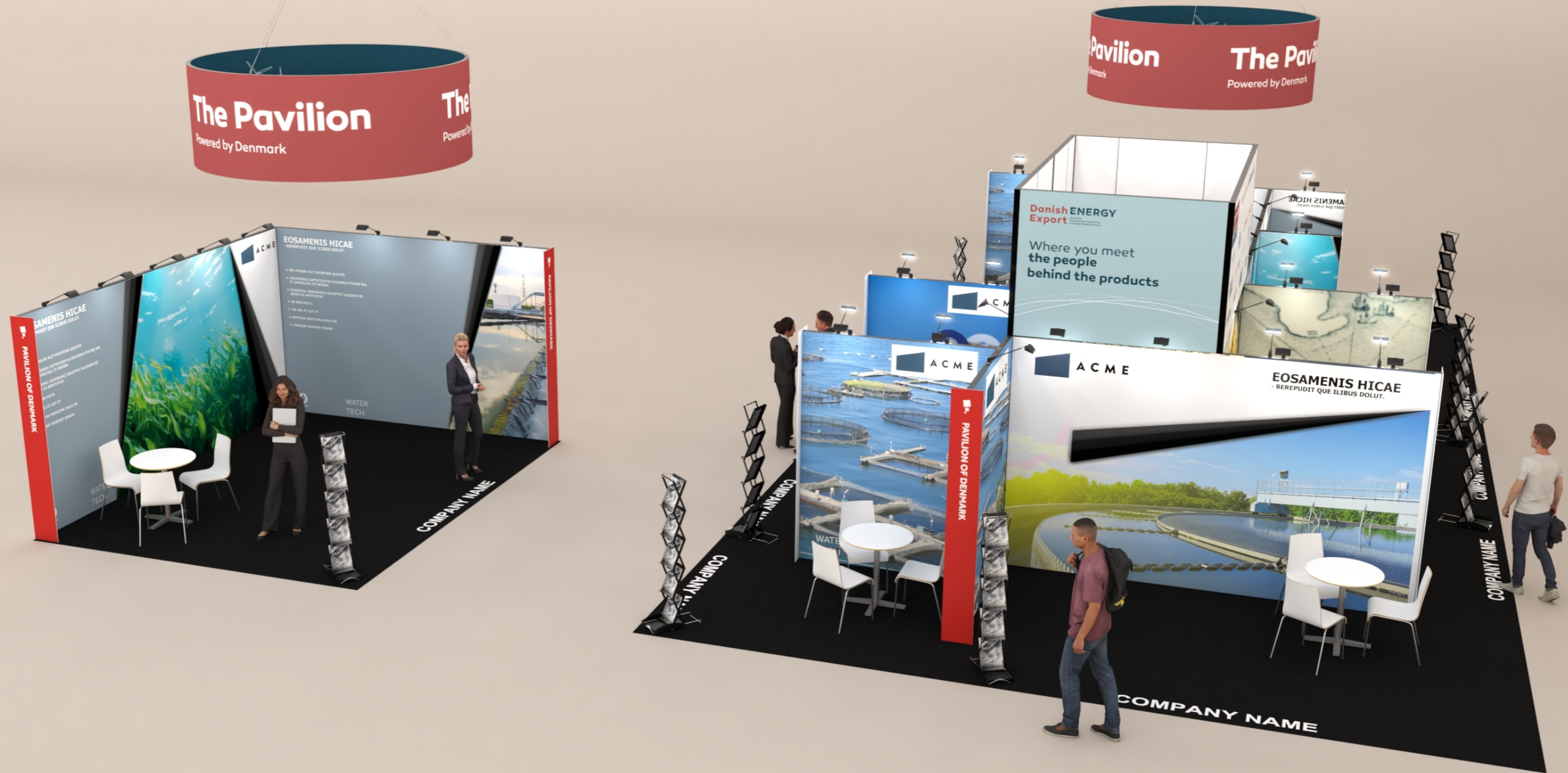

**Danish ENERGY Export**

# Table of Contents

Cover	1
Table of Contents	2
3D View 1	3
3D View 2	4
3D View 3	5
3D View 4	6
3D View 5	7
3D View - DEE Area	8
Floor Plan	9
Graphics Dimensions	10
Elevations	11
Floor Plan - Aluvision	12
Info	13



# 3D View 1

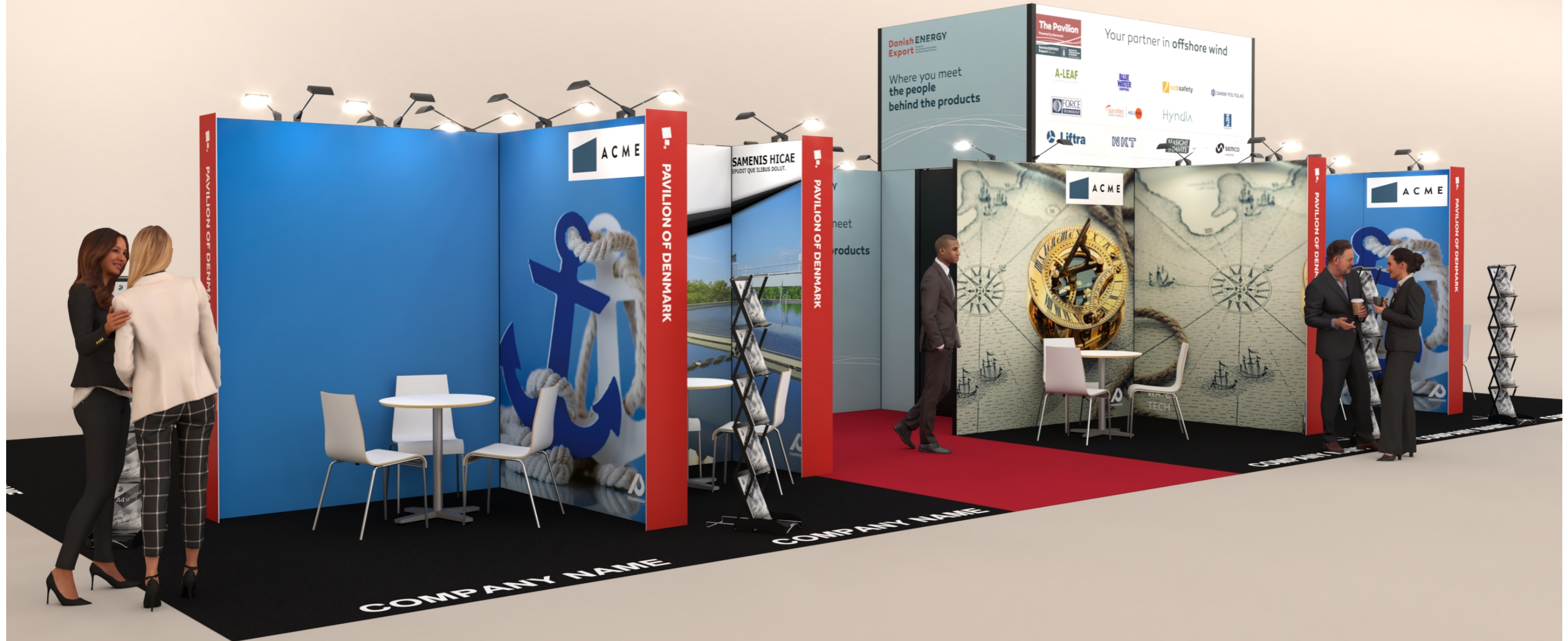



# 3D View 2

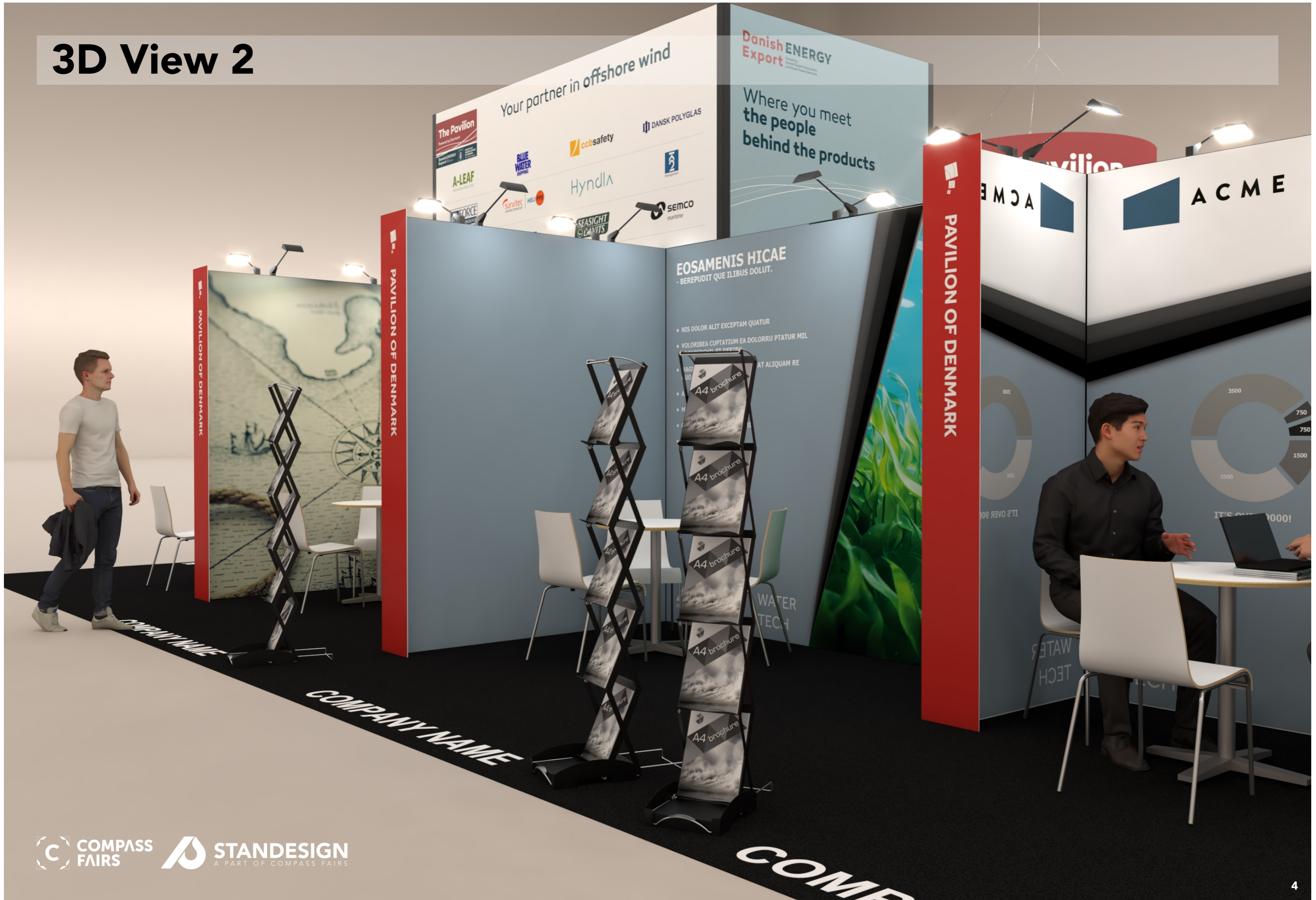



# 3D View 3

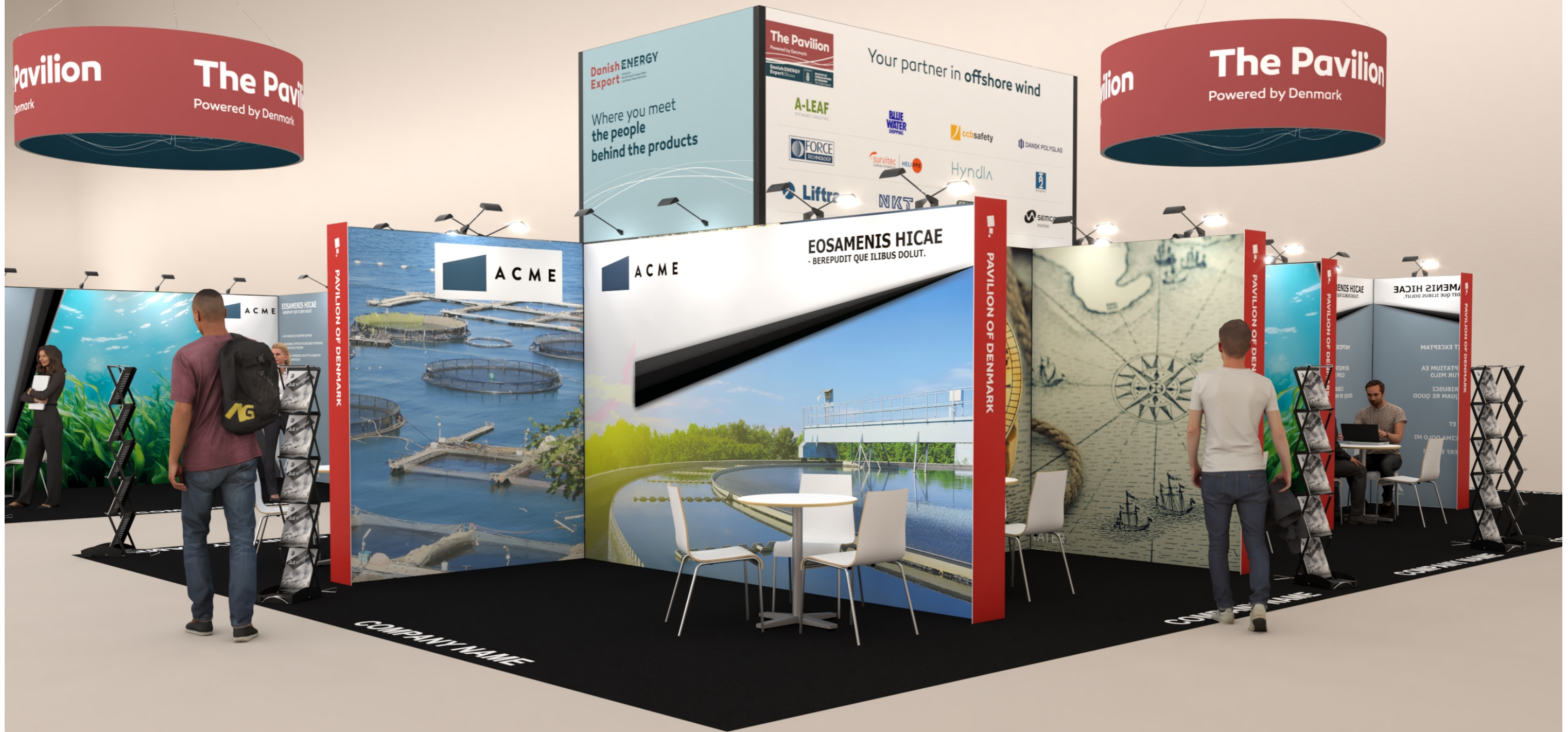



# 3D View 4





# 3D View 5

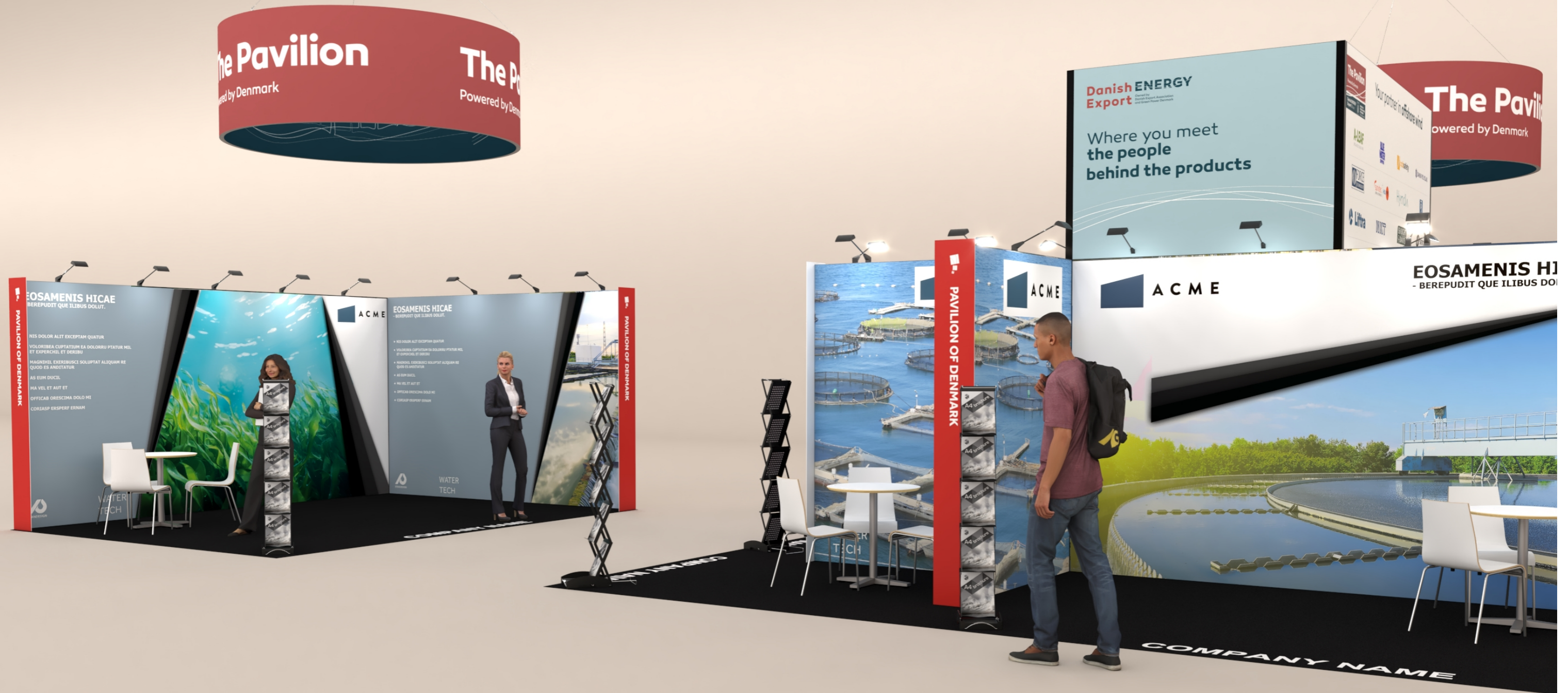



# 3D View - DEE Area





# Floor Plan

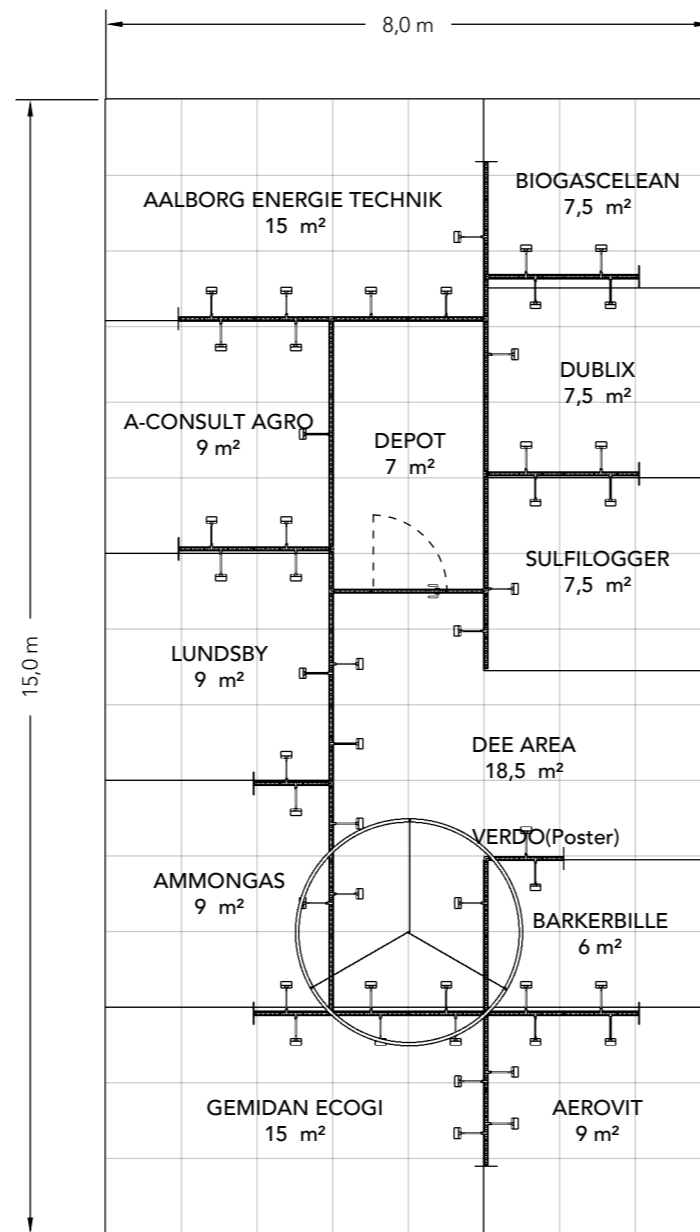
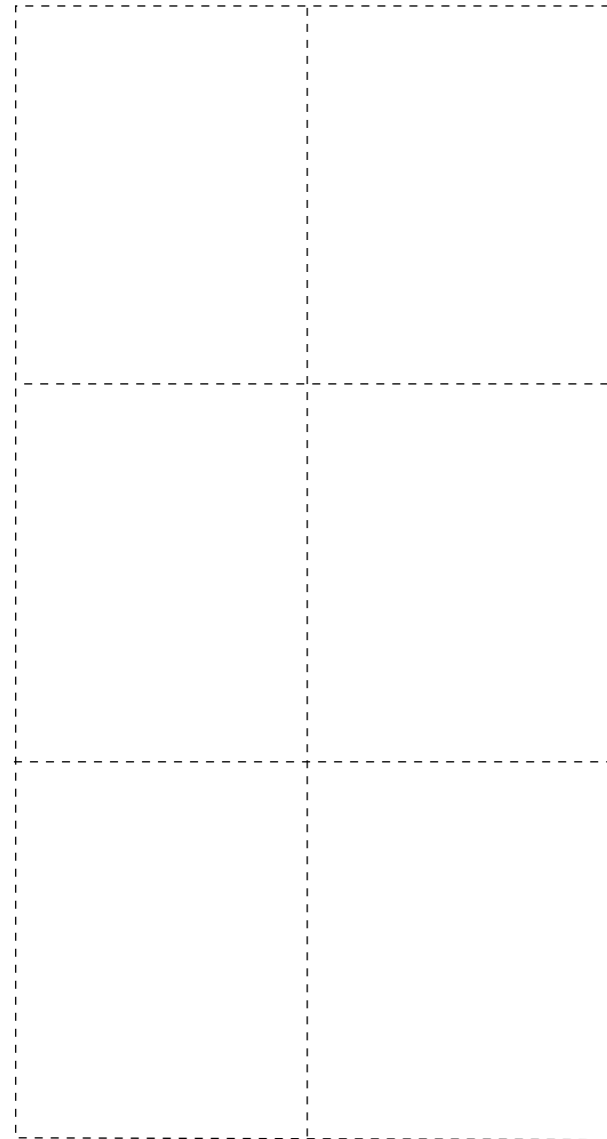

**Booth:115/214**  
**Hall:A4**

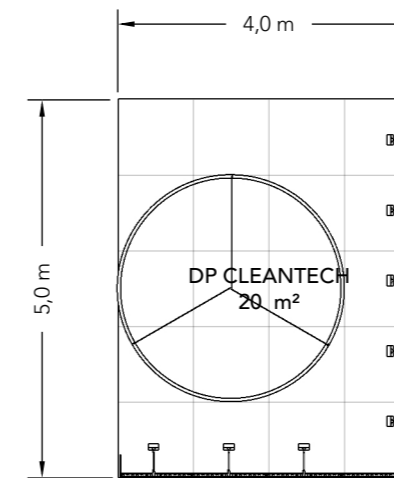

**Booth: 212**  
**Hall:A4**



# Graphics Dimensions

HEIGHT = 2480 mm

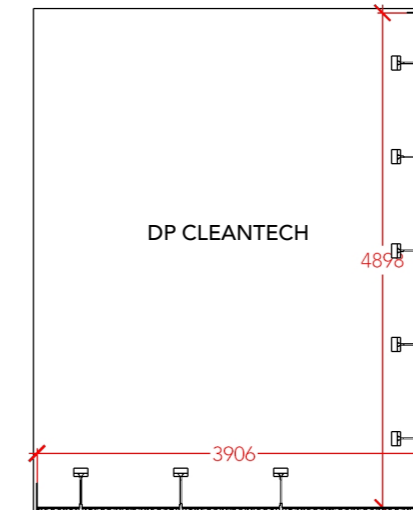
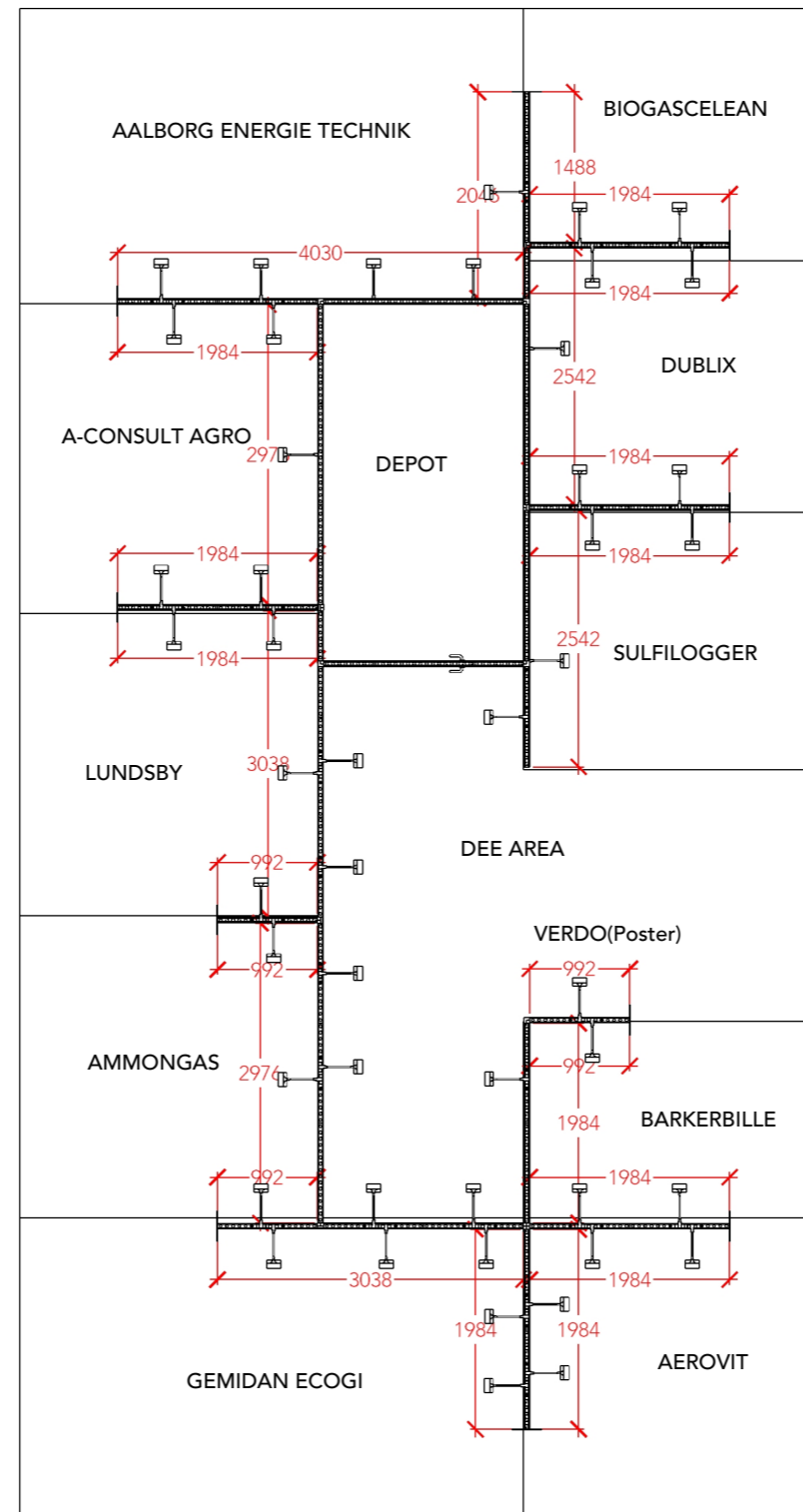



# Elevations

## Front

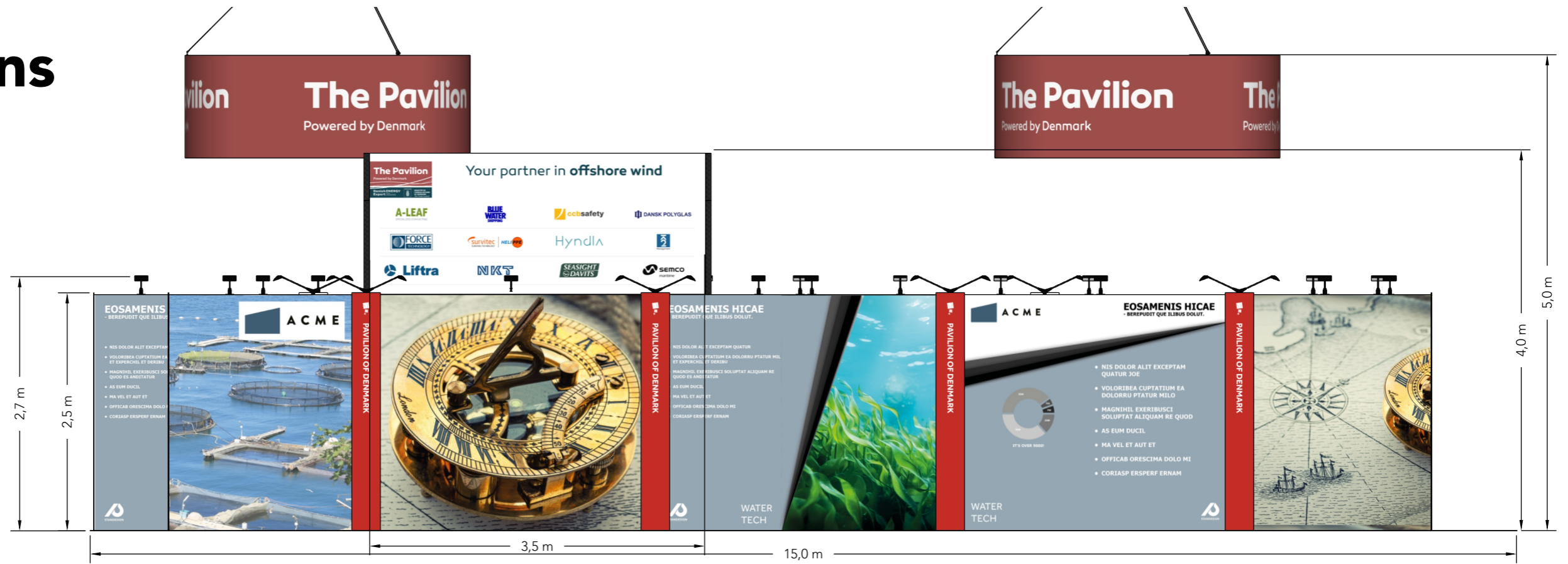

## Side

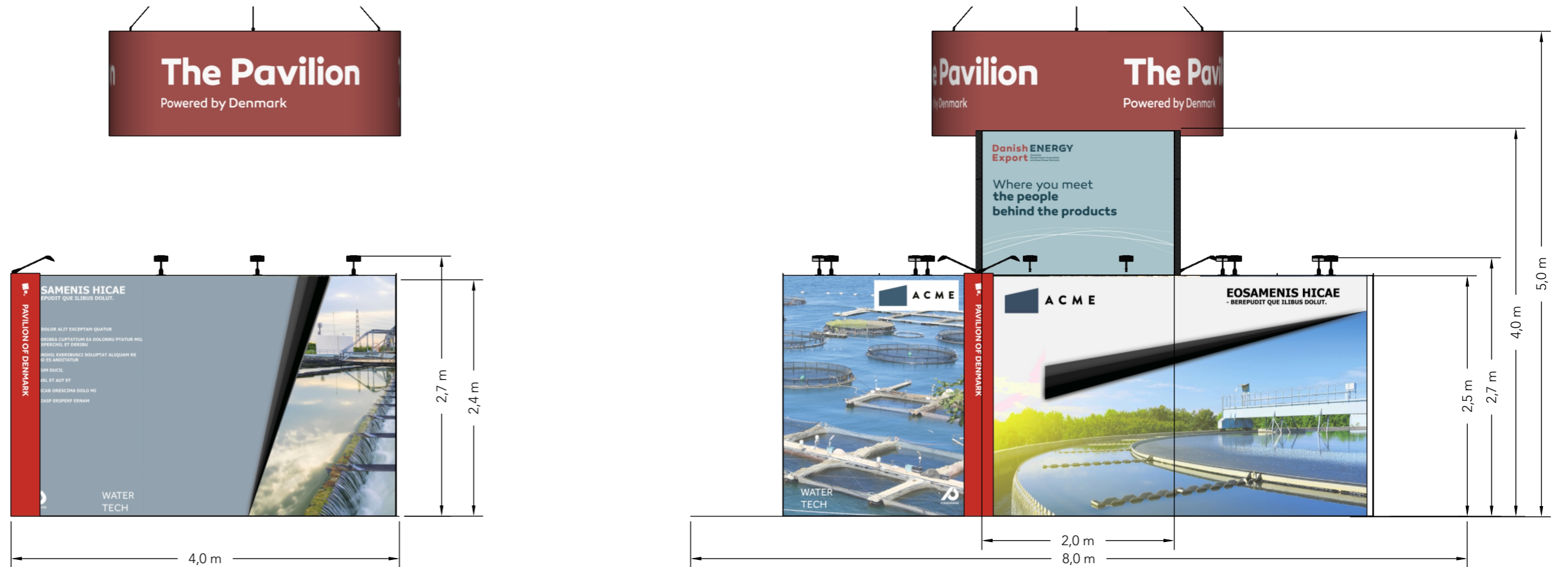



# Floor Plan - Aluvision

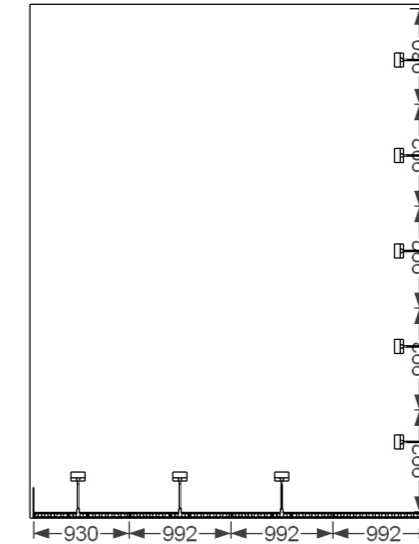
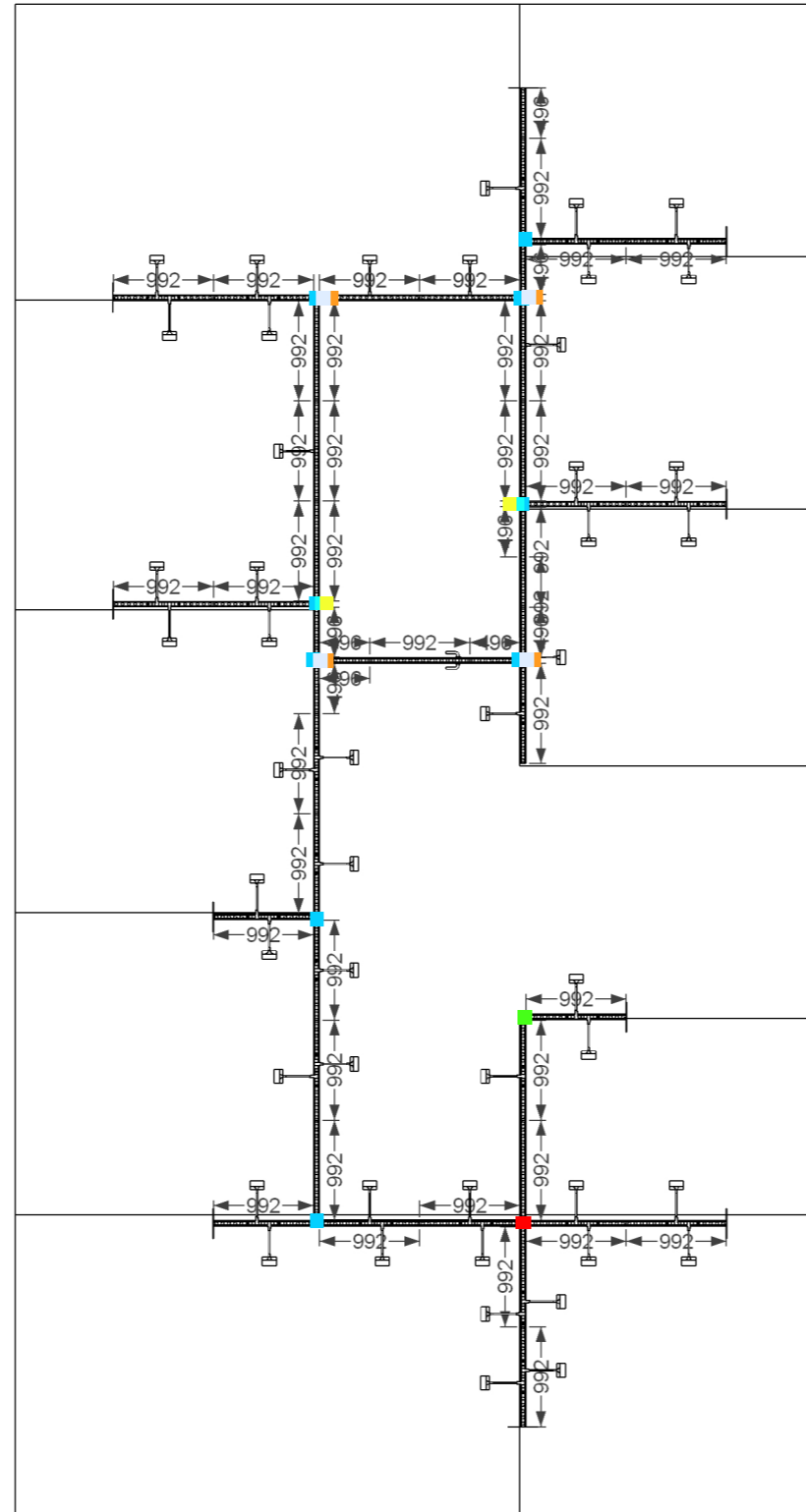

- = OMNI - 55 - X - CORNER A1 PROFILE 2480 mm
- = OMNI - 55 - L - CORNER A1 PROFILE 2480 mm
- = OMNI - 55 - L - CORNER A1 PROFILE 992 mm
- = OMNI - 55 - L - CORNER A1 PROFILE 496 mm
- = OMNI - 55 - T - CORNER A1 PROFILE 2480 mm
- = OMNI - 55 - T - CORNER A1 PROFILE 992 mm
- = OMNI - 55 - T - CORNER A1 PROFILE 496 mm



# Info

Client: Danish Energy Export  
Exhibition: IFAT 2024

Project no.: EXP-IFA-24-05  
Designed By: SMM  
Hall: A4  
Booth: 115/214 + 212

Creation Date: 31.01.2024  
Revision Date: 04.04.2024  
Revision no.: I

Comments:

The drawing is indicative and without responsibility. The drawing is NOT to scale. The stand-builder will have the final call in all decisions regarding stability and security. Some products are only shown to indicate locations, but not the actual product as this product may be changed.  
All design is subject to copyright by Compass Fairs A/S and Standesign A/S

